

PROD.Nr.:

Verkaufsstand 1718 14MM FOROB1  
Art.Nr. 221.1718.00.00

Ean.Nr. 4004581585136

Stand: 2428

weka Holzbau GmbH, Johannesstr. 16, 17034 Neubrandenburg

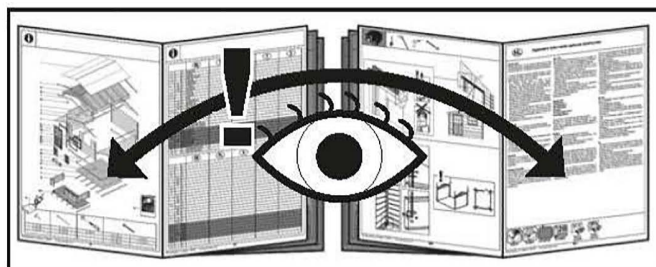

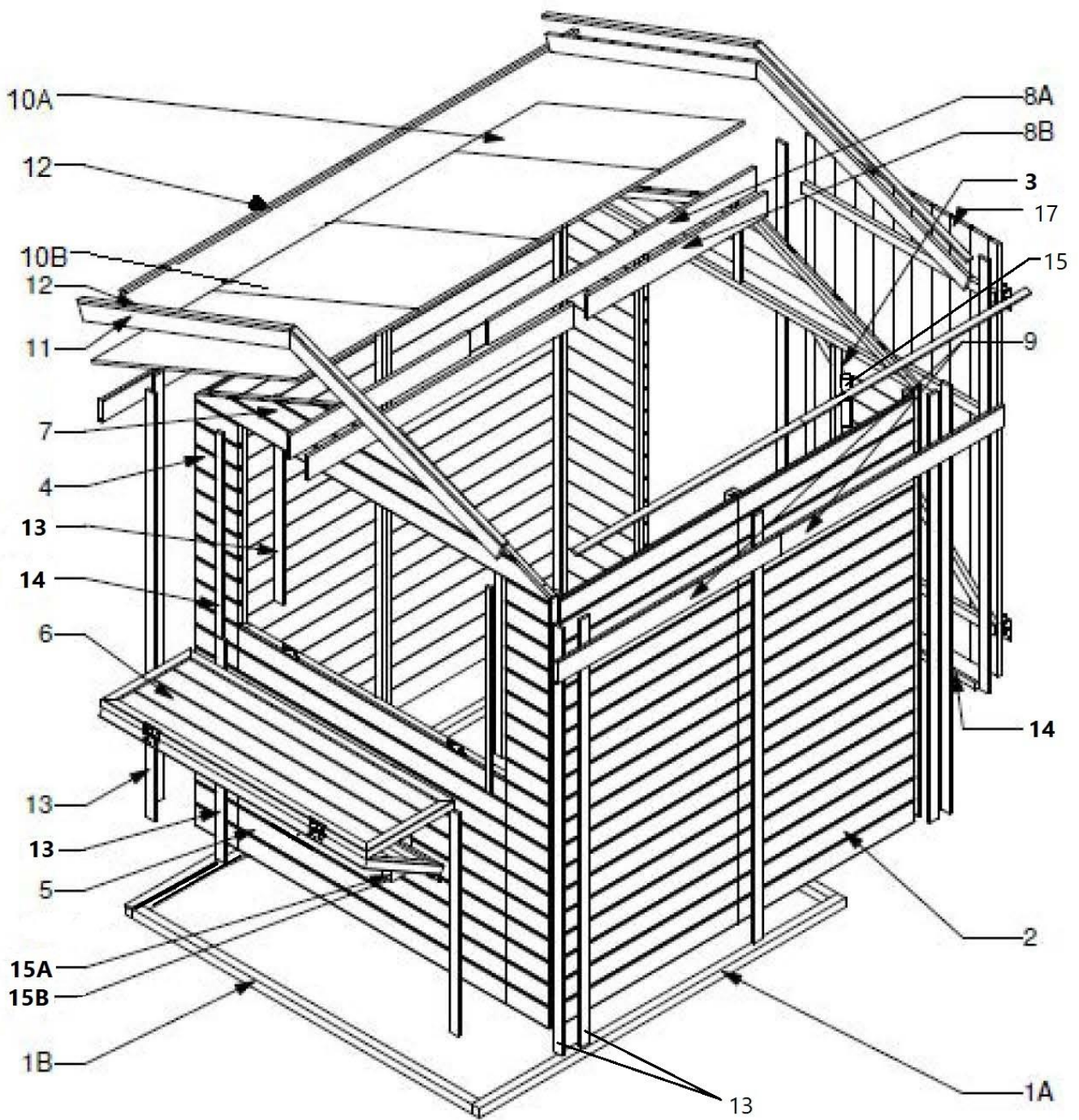



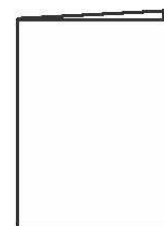











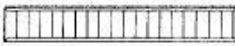
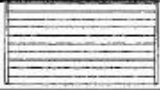
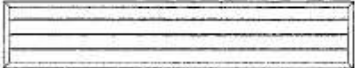





17





18

19







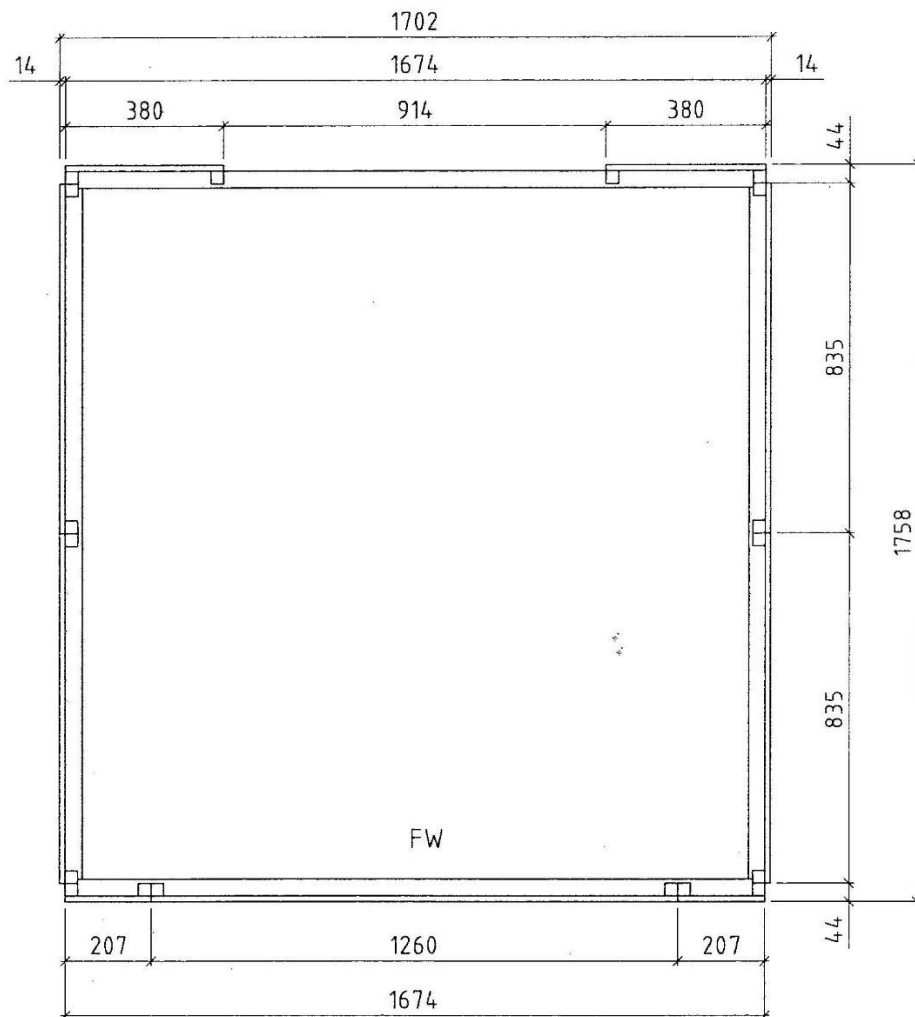









1A	G221.01.0003		40/40/1730	2
1B	G221.01.0004		40/40/1594	2
2.	B221.01.0012		44/835/1772	4
3.	B221.01.0013		44/380/1772	2
4.	B221.01.0014		44/207/1772	2
5.	B221.01.0015		44/1260/940	1
6.	B221.03.0006 B221.03.0007		60/1250/408	1 1
7.	B221.02.0011		44/1674/375	2
8A	G221.06.0011		18,5/96/1260	2
8B	G221.06.0012		18,5/96/850	2
9.	G221.06.0013		18,5/96/1055	4
10A	G221.08.0002		15/570/1045	6
10B	G221.08.0003		15/400/1045	2
11.	G221.05.0007		18,5/70/1070	4
12.	G221.05.0008		14/45/1070	8
13.	G221.05.0006		14/45/1780	15
14.	G221.05.0009		14/25/914	3
15	R002.0190.0240	 	30/30/240	3
16A	G221.06.0014	 	40/90/190	2
16B	G221.06.0015		14/45/100	2
17	B221.03.0008		44/908/1780	1

18			Montagematerial	1 X
19			Aufbauanleitung	1X
20			Vorwort	1 X



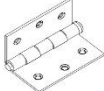

1.					St
2.	K001.2535.0004		3,5x25 mm	61	St
3.	K001.3035.0004		3,5x30 mm	108	St
4.	K001.3535.0004		3,5x35 mm	134	St
5.	K001.6040.0004		4,0x60 mm	20	St
6.	K005.7006.0001		M6x70 mm	14	St
7.	K005.9008.0001		M8x90 mm	16	St
8.	K005.6006.0001		M6x60 mm	2	St
9.			M6	16	St
10.			M8	16	St
11.			6,4 8,4	16 / 16	St
12.	K051.4000.0001		100 mm	4	St
13.				4	St
14.	K065.9000.0001			1	St
15.	K067.0250.0001			2	St
16.					St
17.					St
18.	K038.5000.0001		50x50mm	4	St

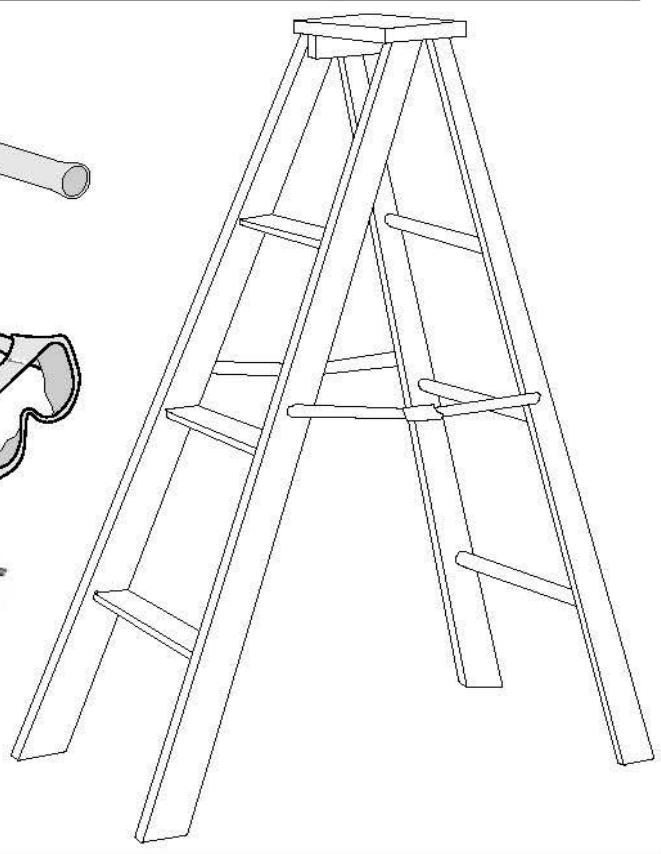
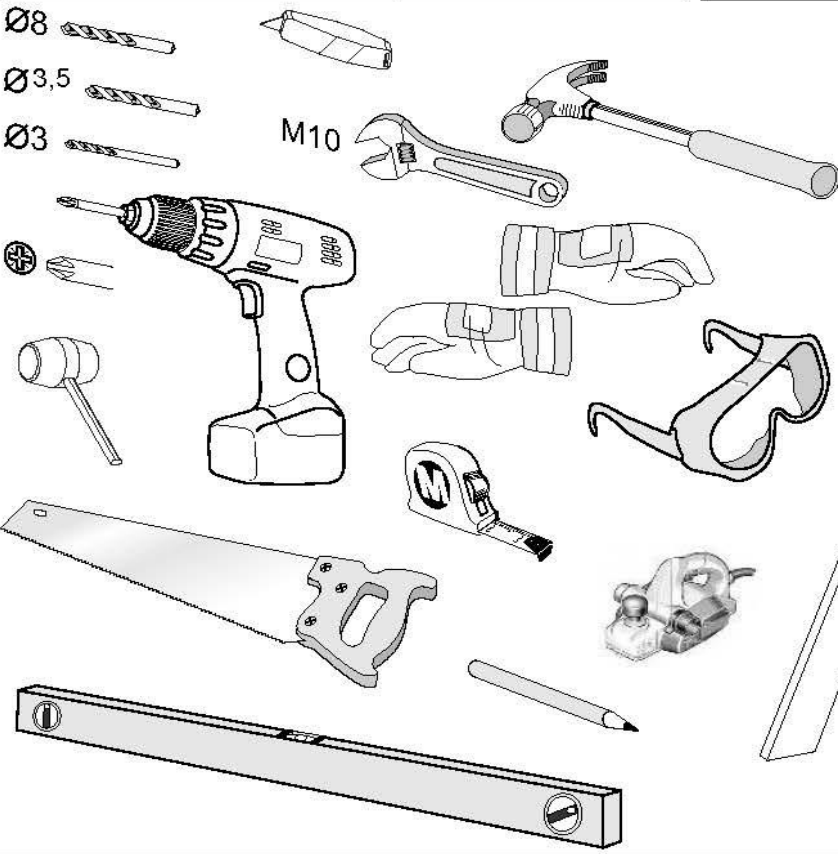
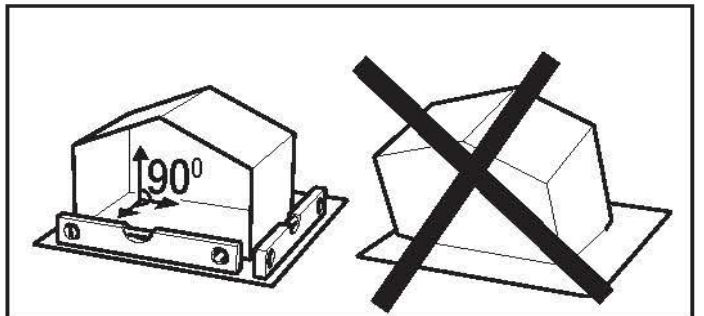
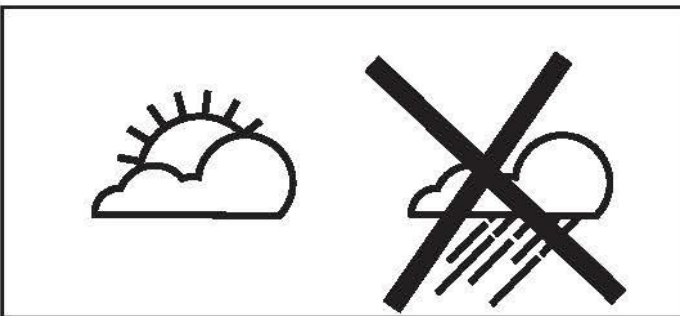
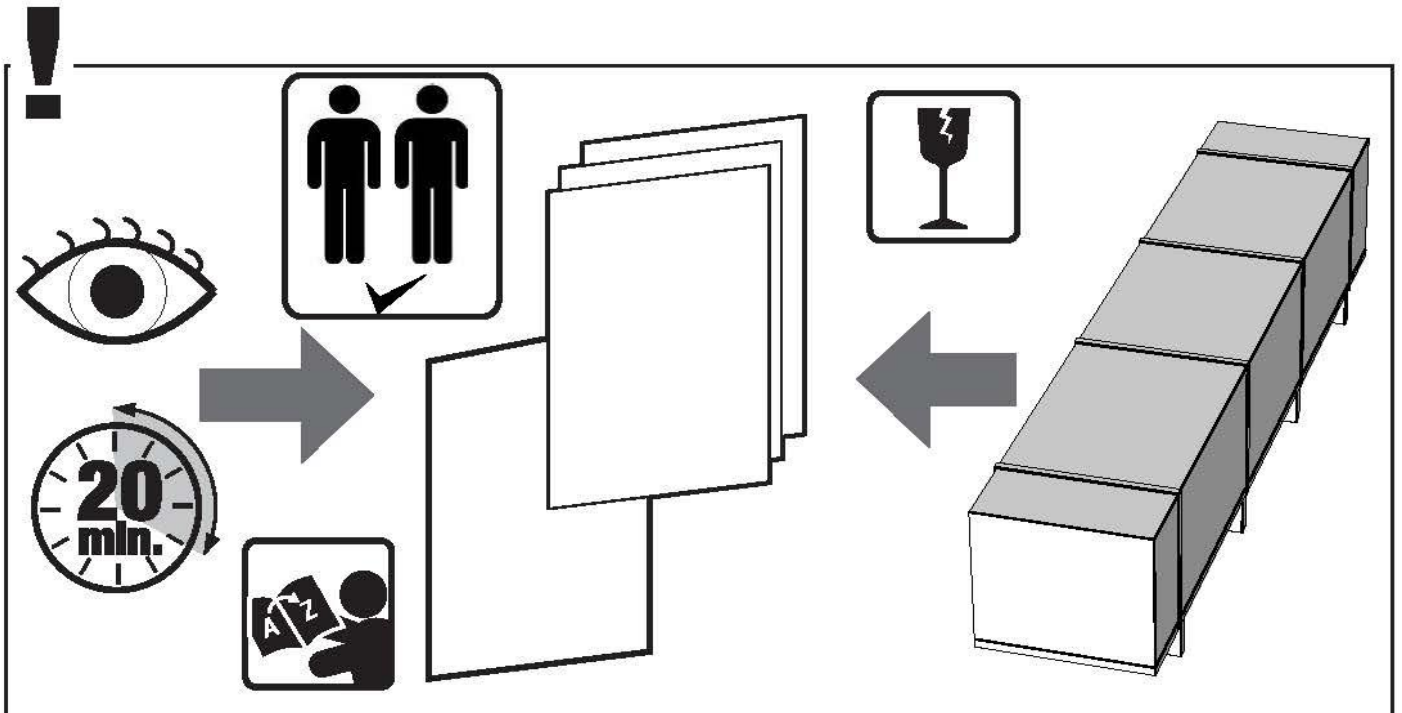
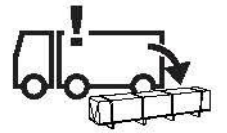
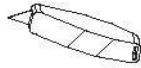
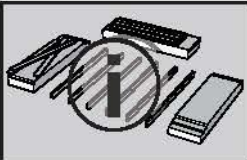

1

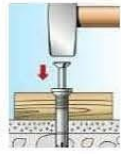
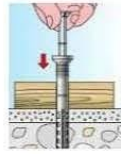
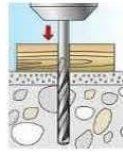
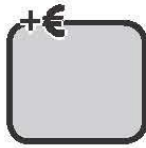
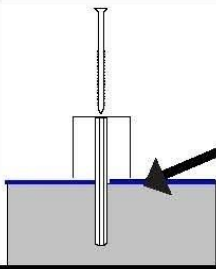
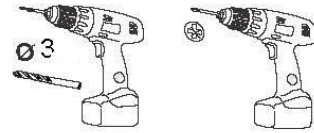
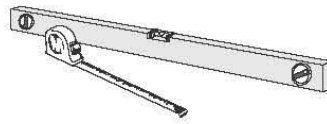

POS

1A  38X38X1730 2X

1B  38X38X1594 2X



4X

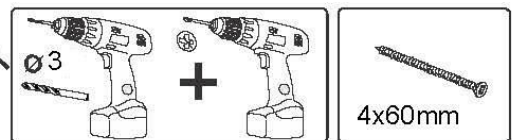
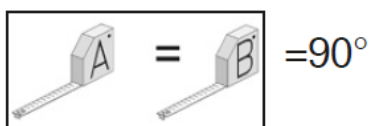
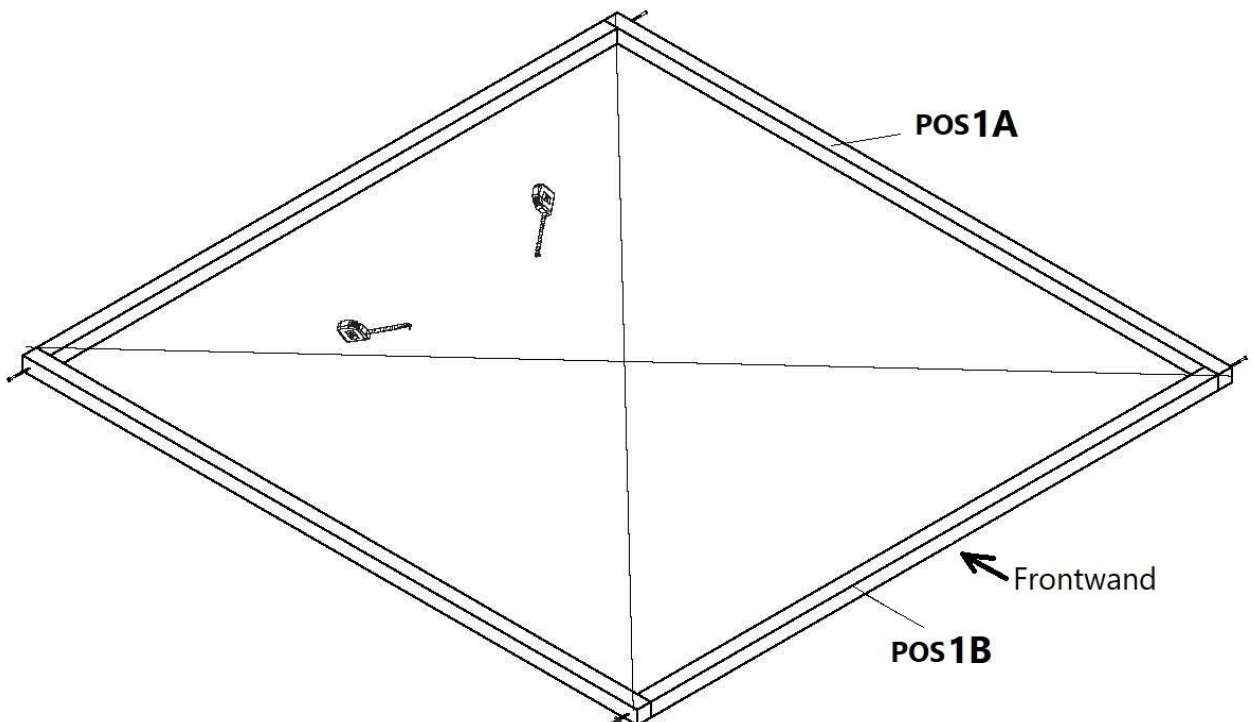



2

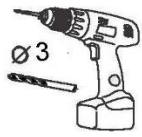
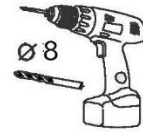

POS

2.  835x1772mm 1X

3.  380x1772mm 1X

 5X  
3,5x35mm

 4X  
M8x90mm

 4X  
M8

 4X  
8,4

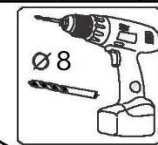
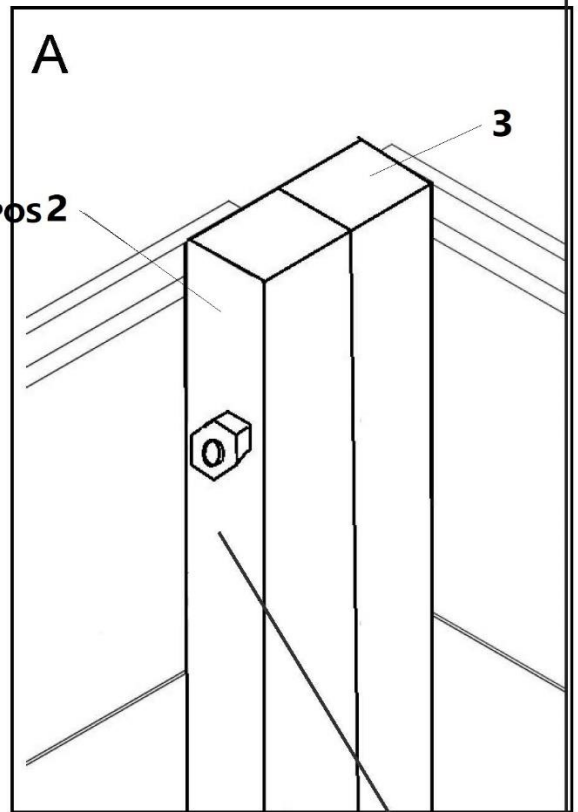
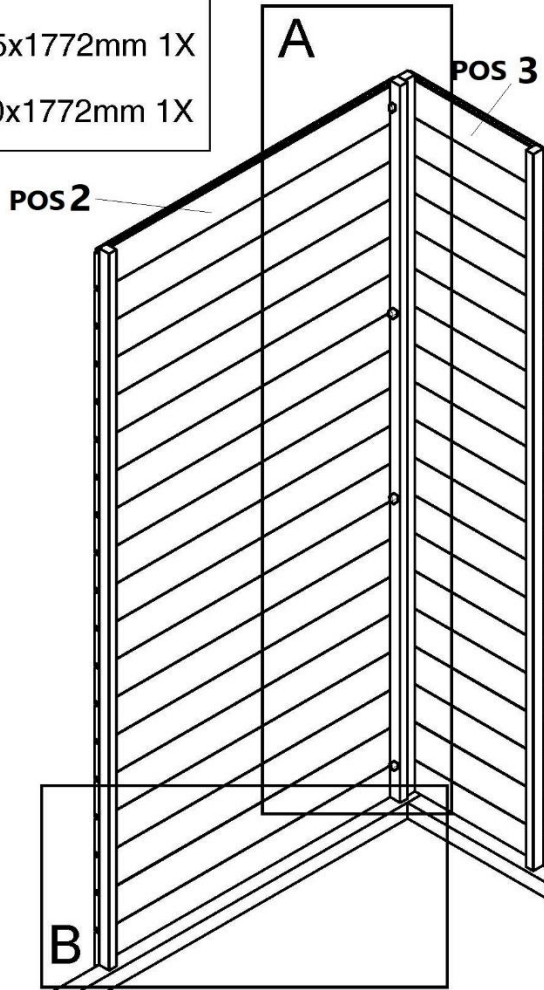

 M8x90mm

 M8

 8,4

Pos. 2 = 3X  
Pos. 3 = 2X

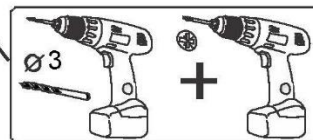
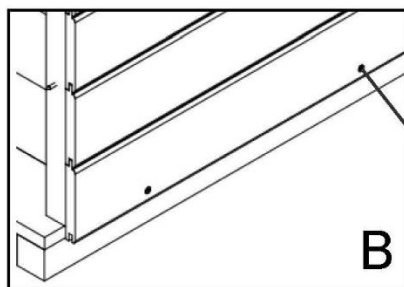
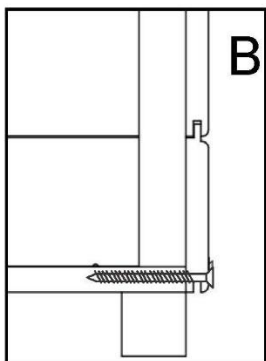

 3,5x35mm

3

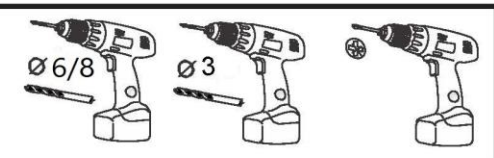
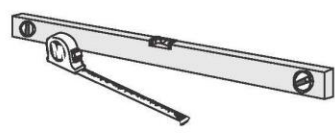

POS

- 2. 835x1772mm 2X
- 3. 380x1772mm 1X
- 4. 207x1772mm 1X

	10X		4X
	8X		12X
			12X

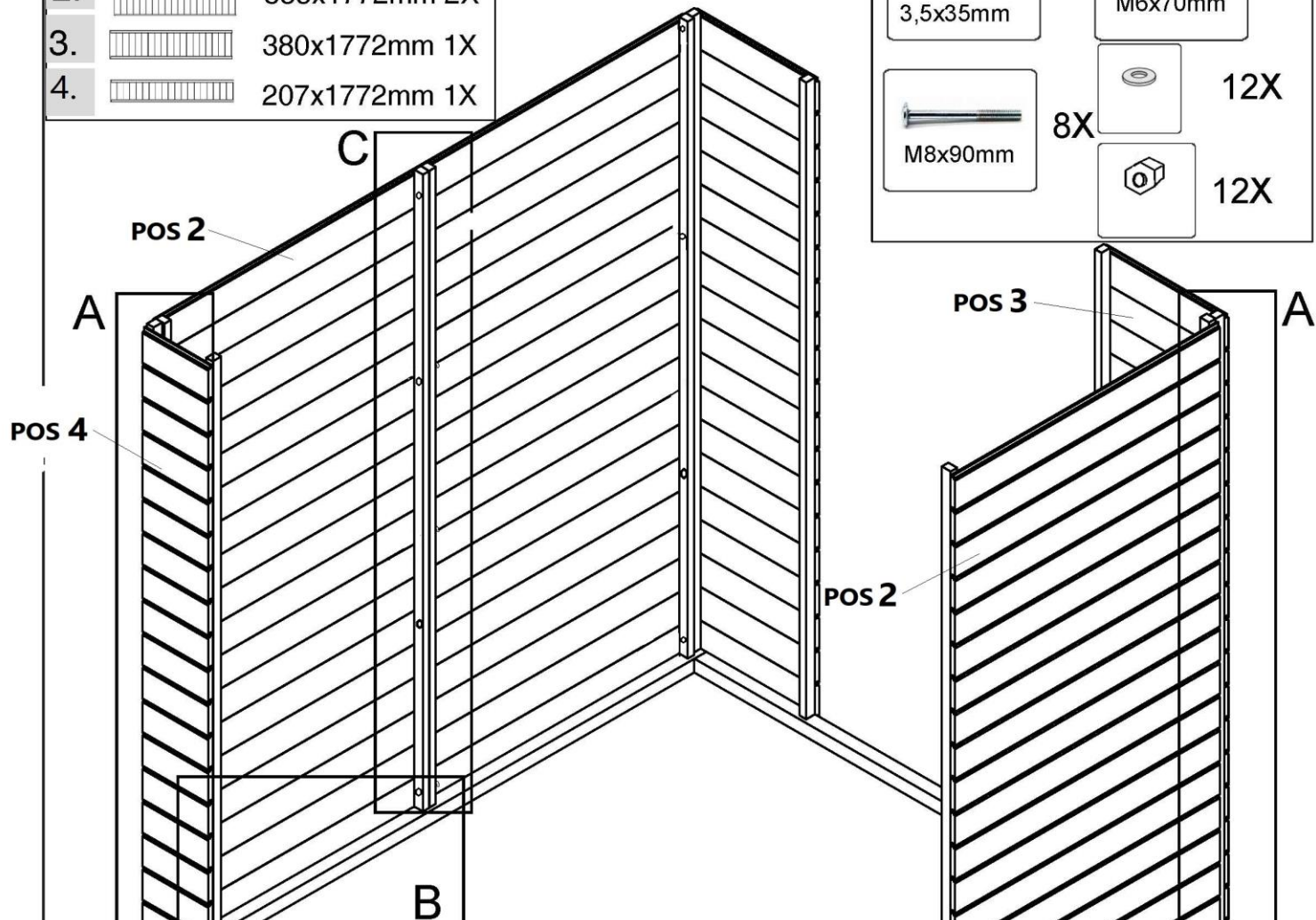

+

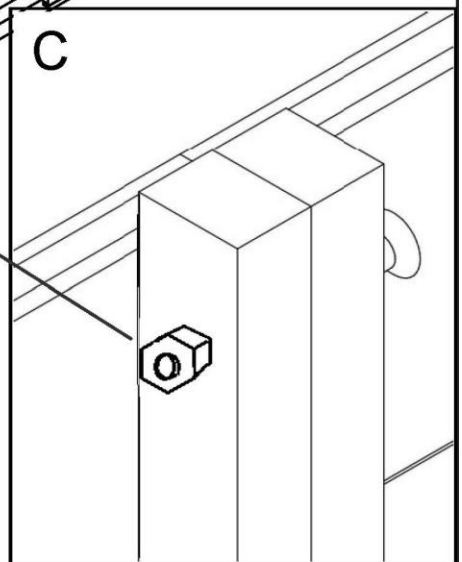
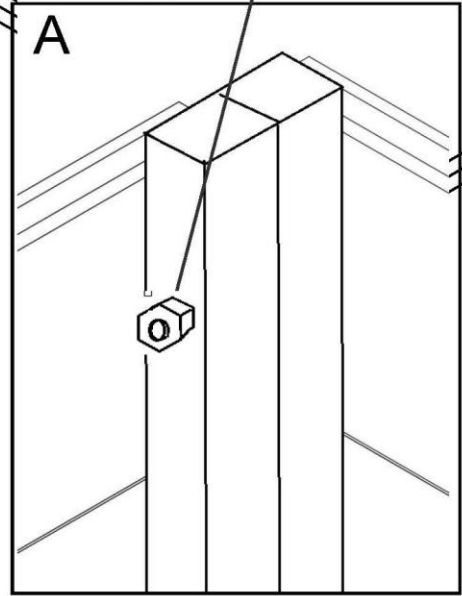
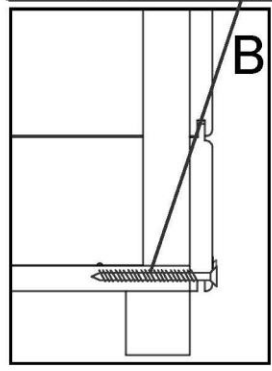



4

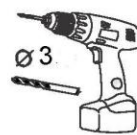

POS

2. 835x1772mm 1X

4. 207x1772mm 1X

5X  
3,5x35mm

4X  
M6x70mm

4X  
M8x90mm

8X

8X

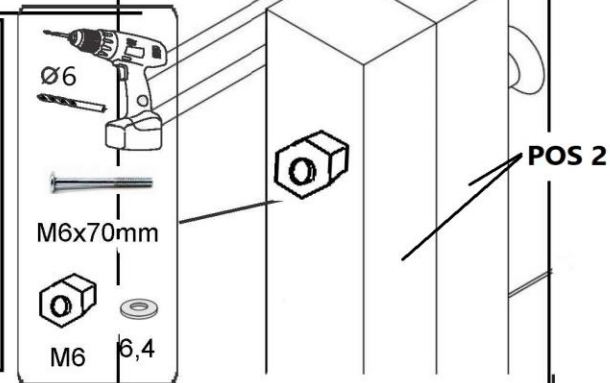
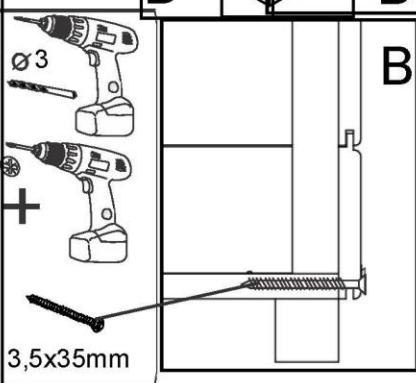
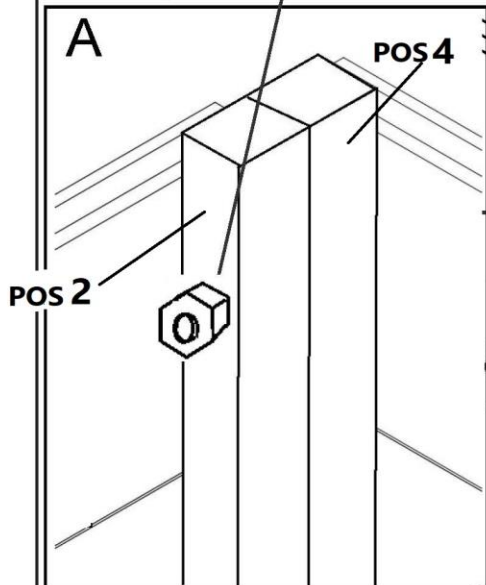
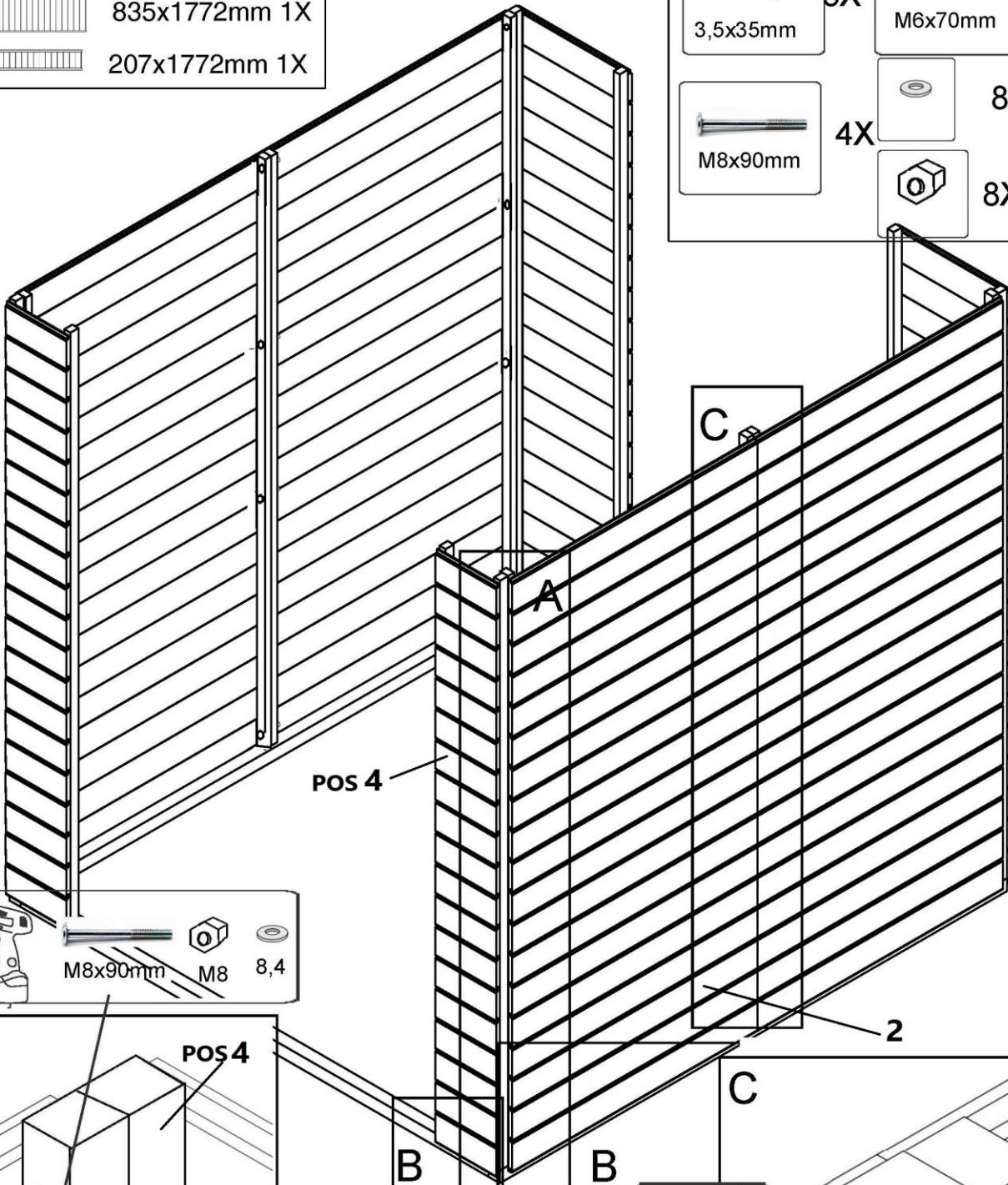



5

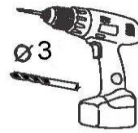
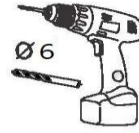

POS

5.



1260x930mm 1X

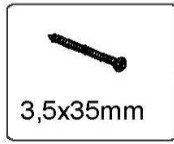

4X

3,5x35mm



4X

M6x70mm

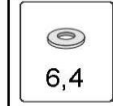

4X

6,4

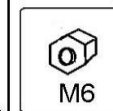

4X

M6

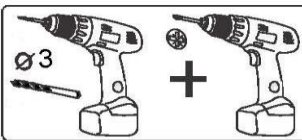
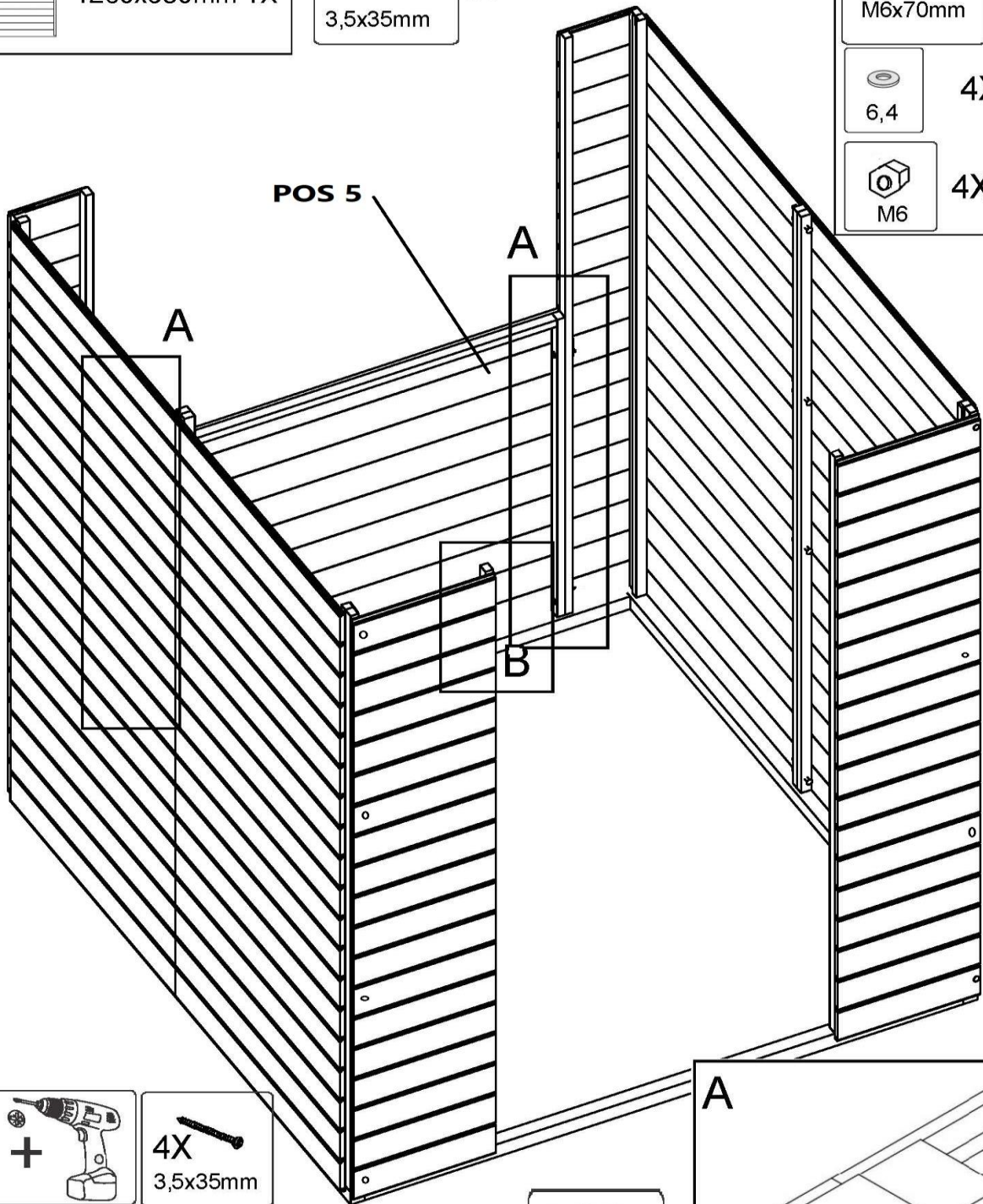

+



4X

3,5x35mm

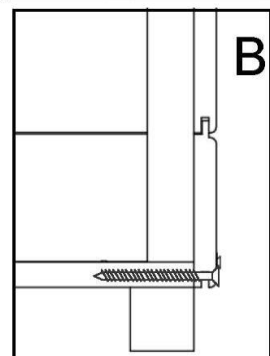

B

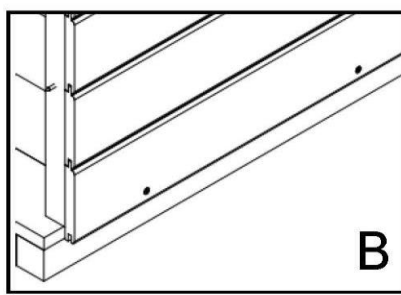

B

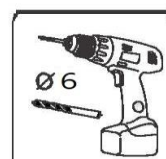

Ø6

M6x70mm



M6



6,4

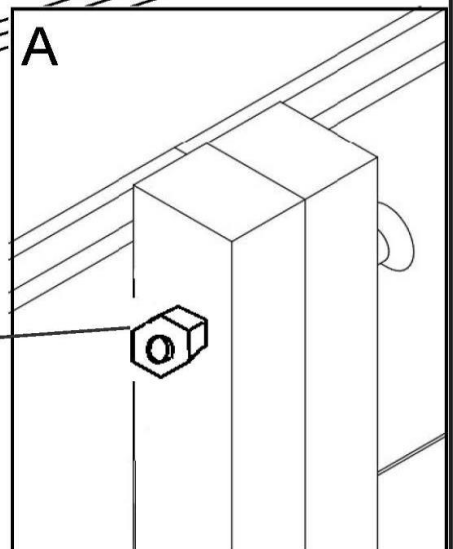

A

6

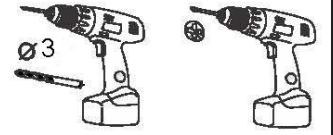
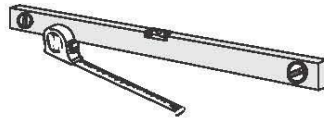

POS

7.  375x1674mm 2X

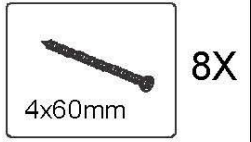
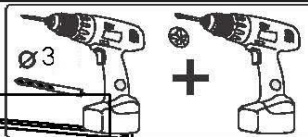

8X

4x60mm

POS 7

B

POS 7

B

A

B

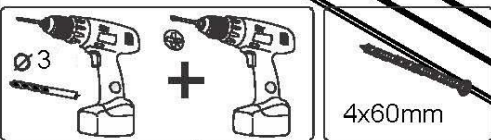

B

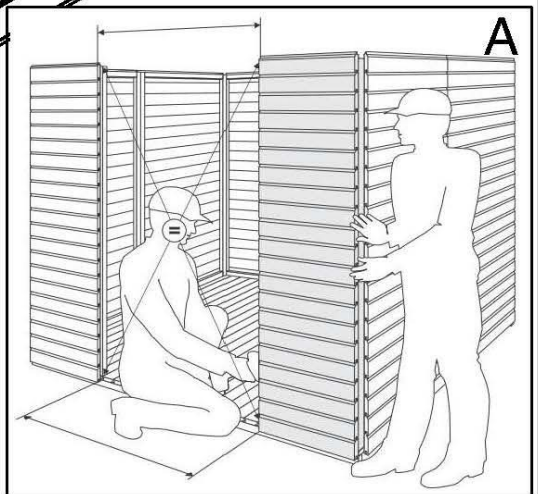
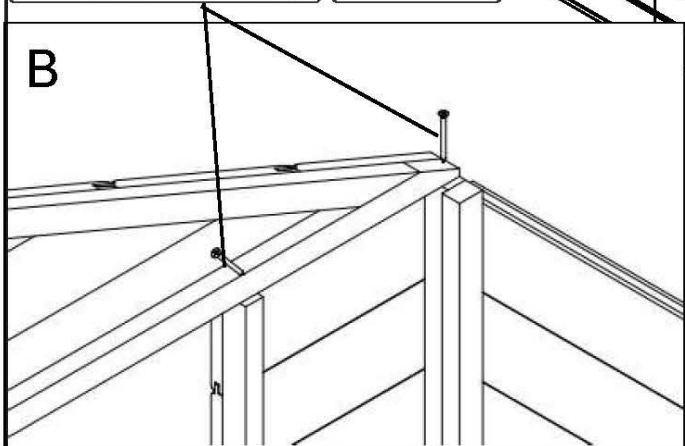



7

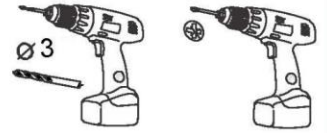
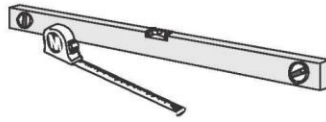

POS

16A



40x90x190mm 2X



4X

3,5x35mm

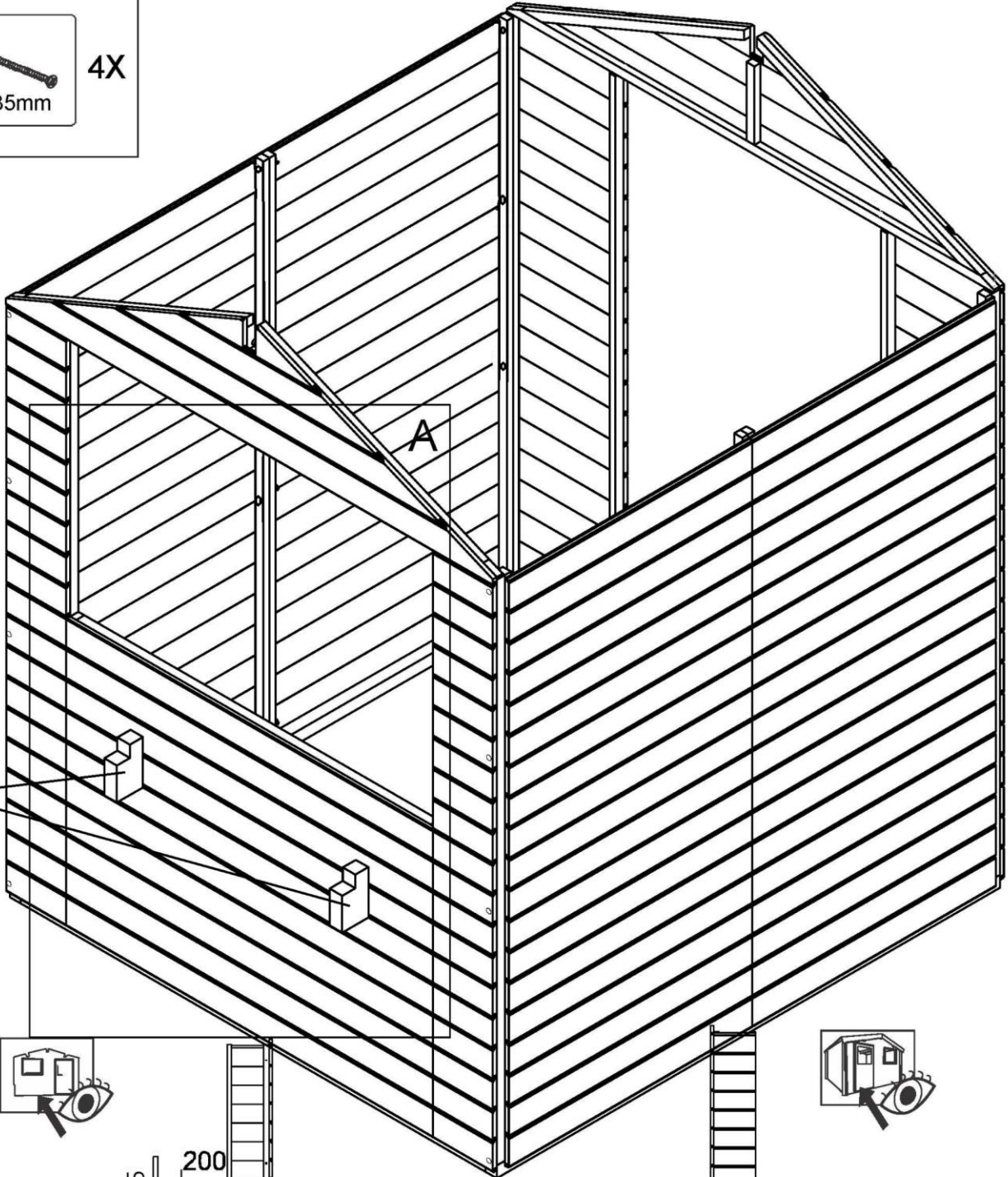

pos16A

A

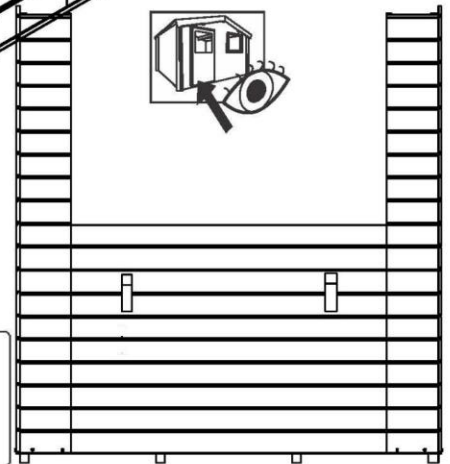
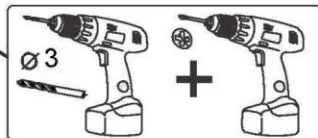
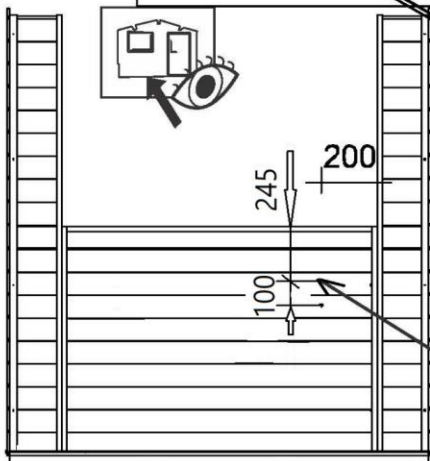



8

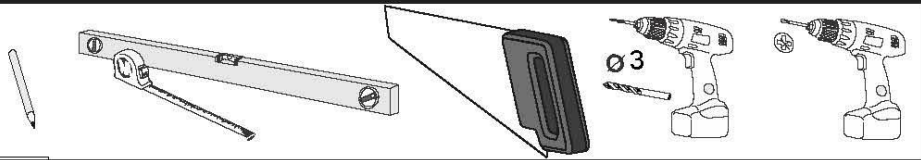

POS

- 13  14x45x1780mm 12 X
- 14  14x25x914mm 2 X



38X

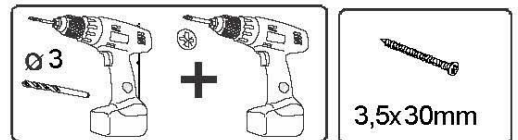
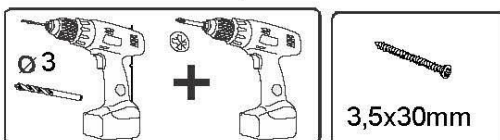
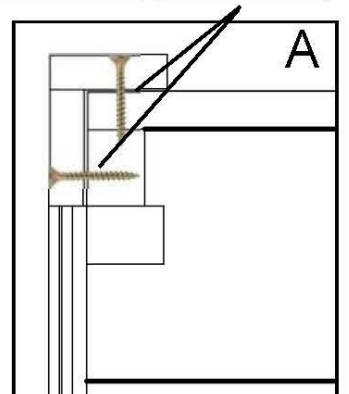
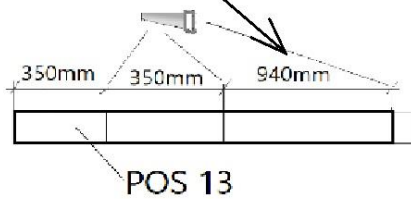
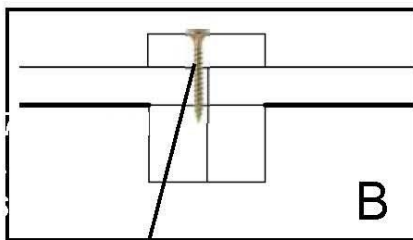
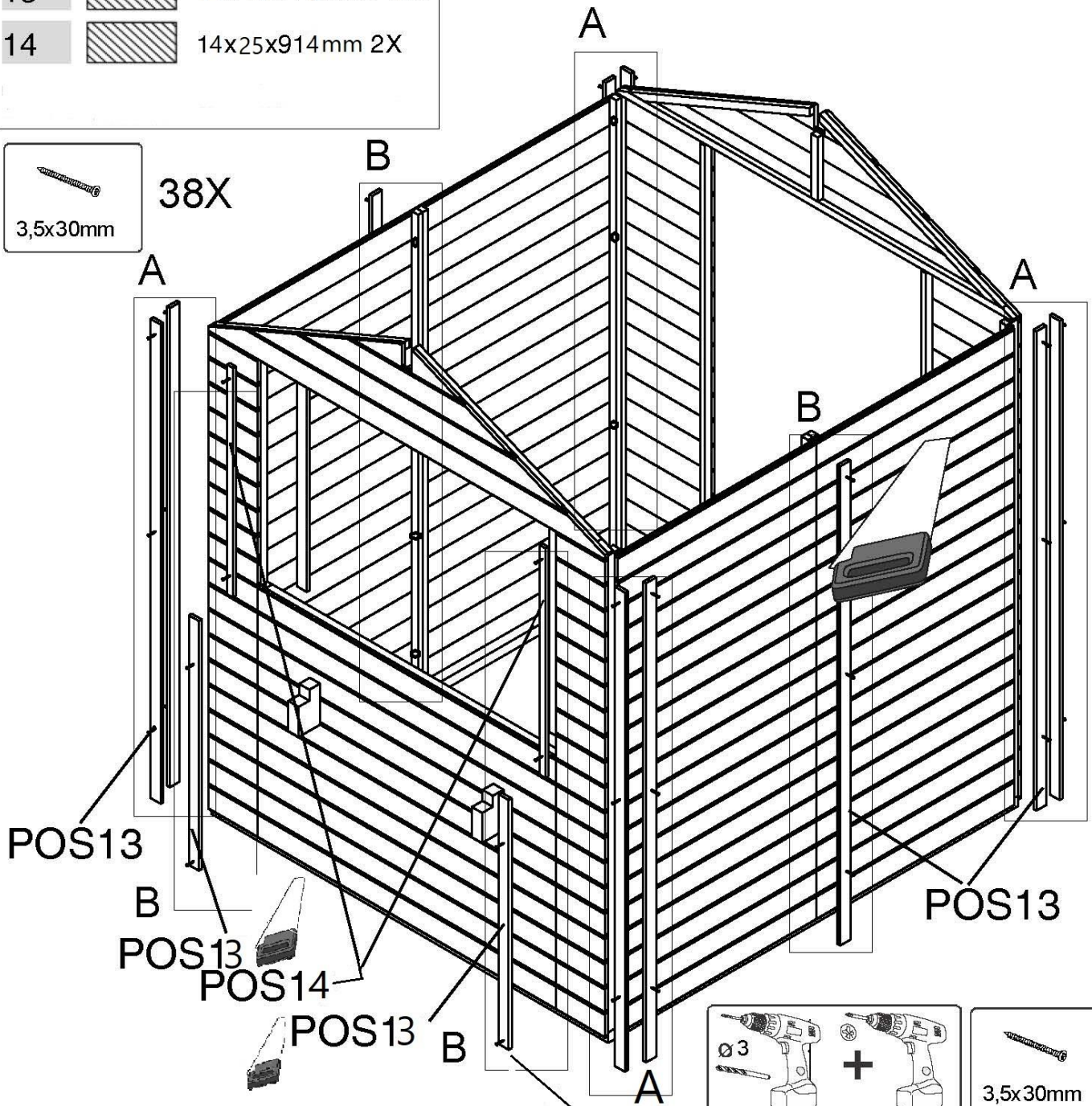

9

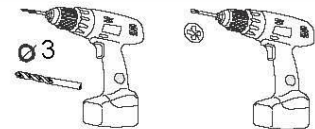
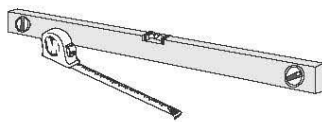

POS

8A  18,5x96x1260mm 2X

8B  18,5x96x850mm 2X

POS

9.  18,5x96x1055mm 4X

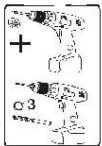

3,5x25mm

300

POS 8B

POS 8A

POS 8B

POS 8A



24X

3,5x30mm



6X

3,5x35mm



12X

3,5x25mm

POS 9

3,5x35mm

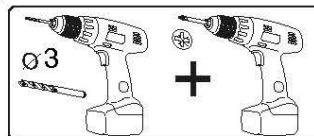
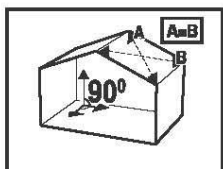
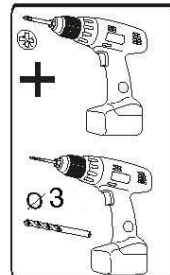

3,5x35mm

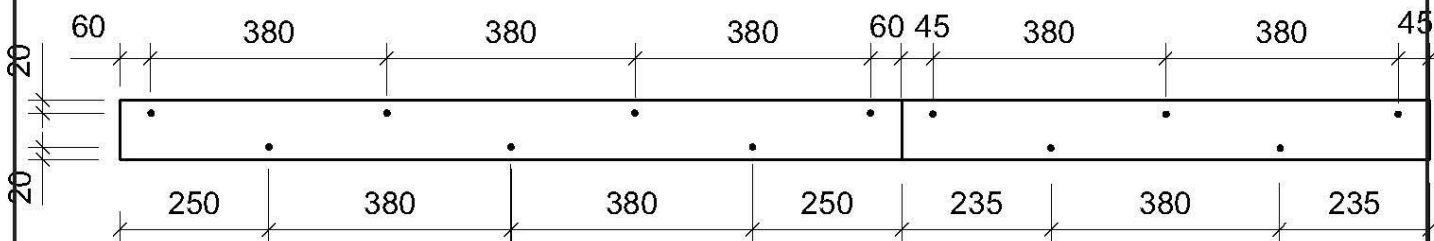



10

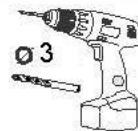
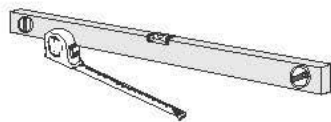

4X

4x60mm

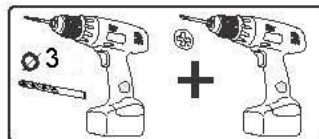

+



4x60mm

POS 8A / 8B

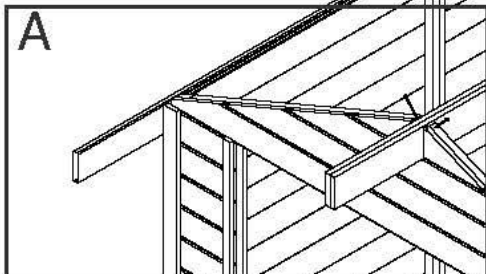

A

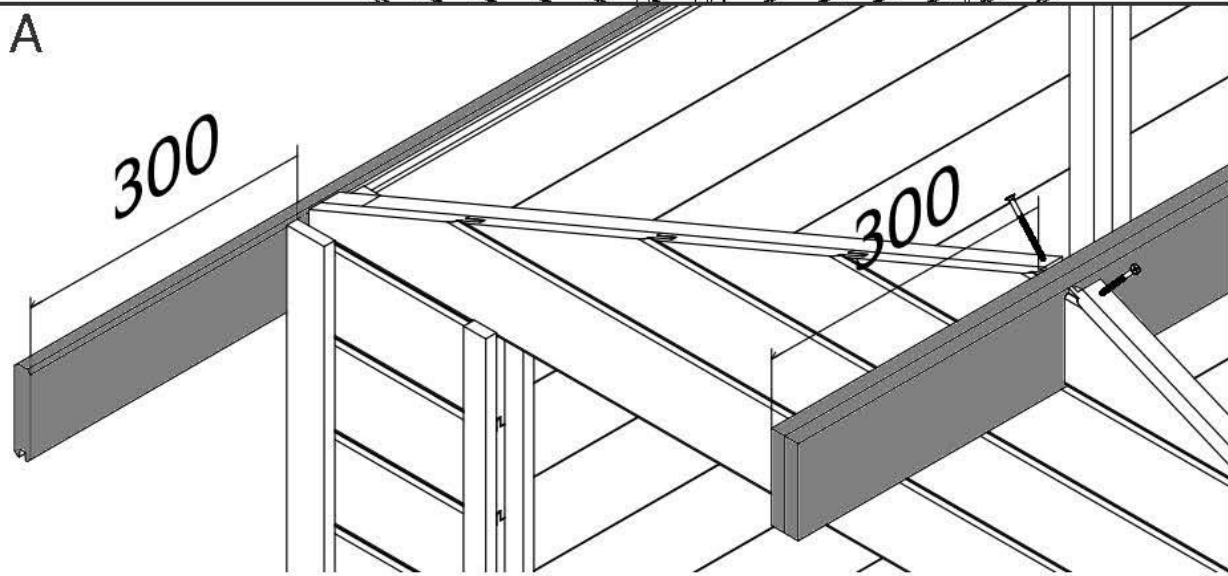
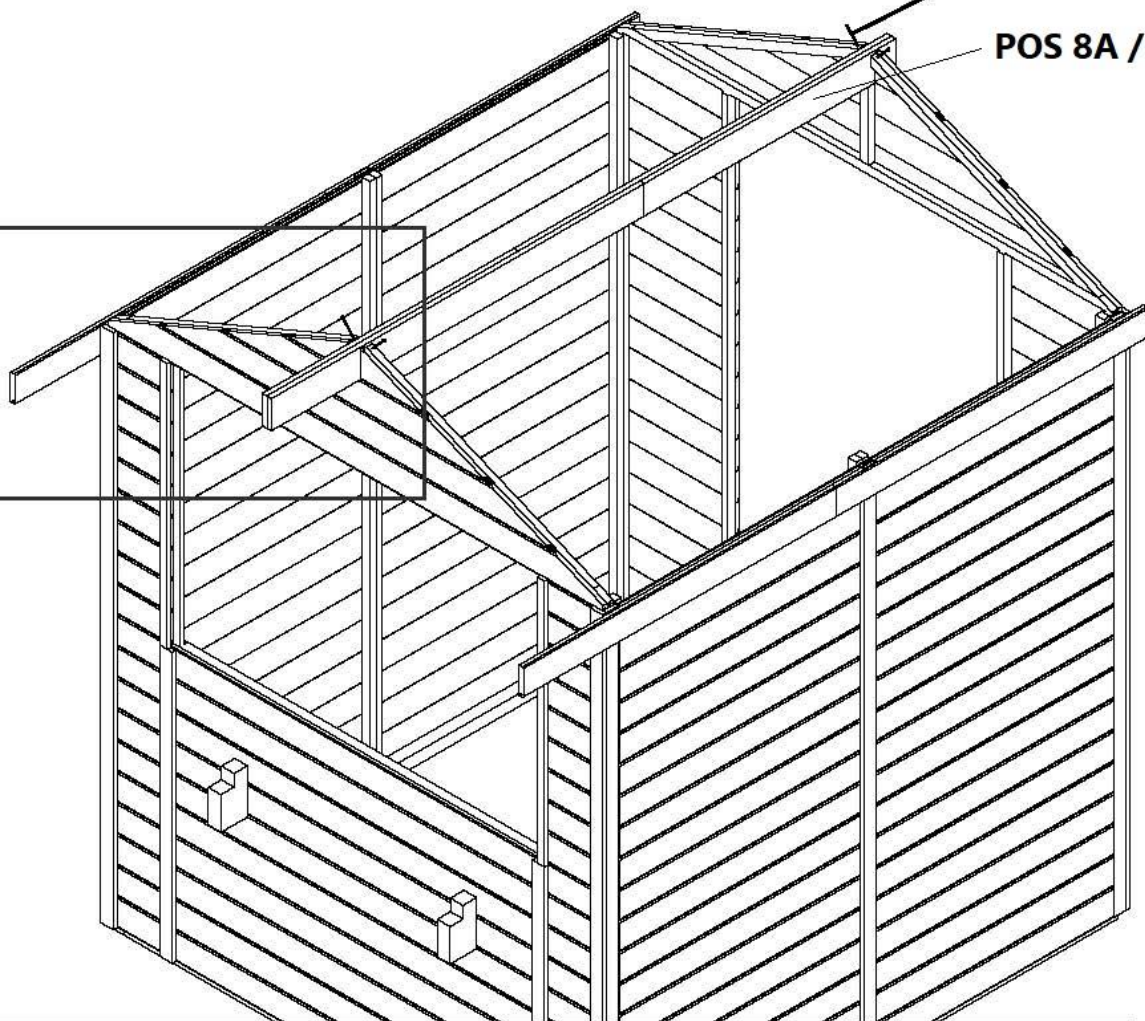

A

300

300



11

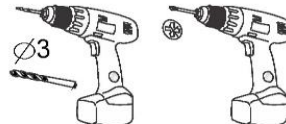
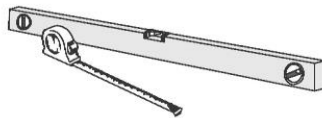

POS

10A



570x1045mm 6X

10B



400x1045mm 2X



3,5x35mm

48X

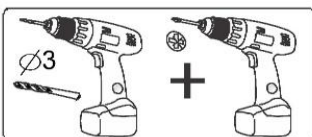
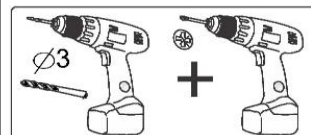
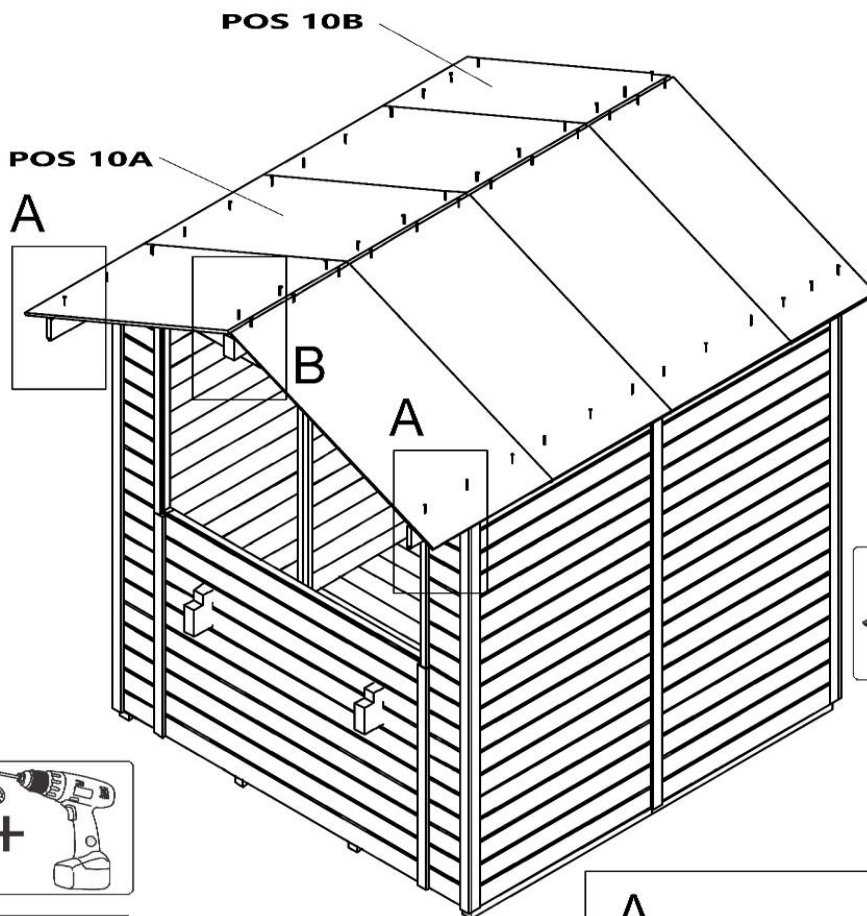

3,5x35mm



3,5x35mm

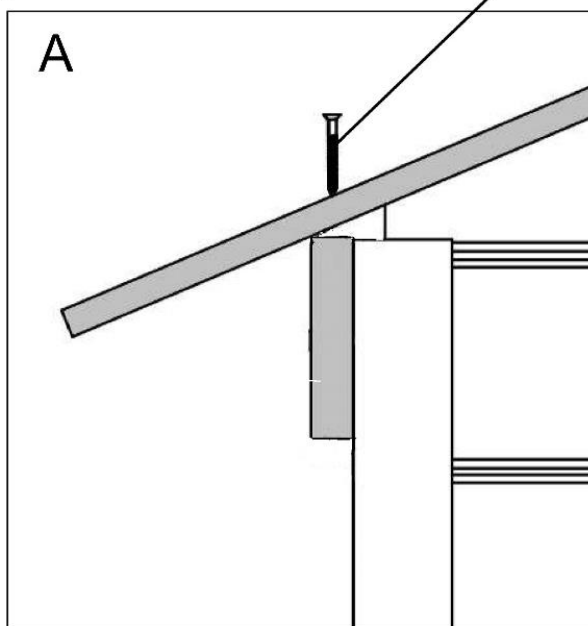
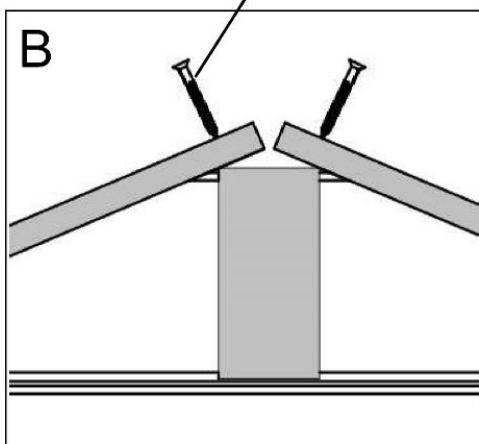

12



POS

11. 18,5x70x1070mm 4X

12. 14x45x1070mm 8X

16B. 14x45x100mm 2X

3,5x25mm 36x

3,5x35mm 20x

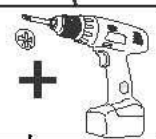

3,5x35mm

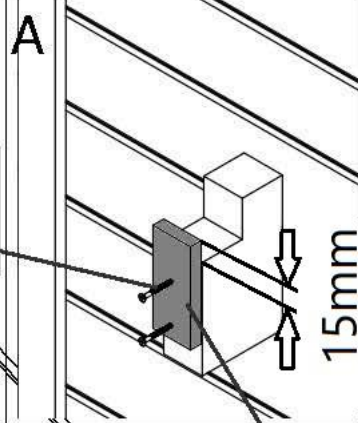

POS16B

12 x

3,5x25mm

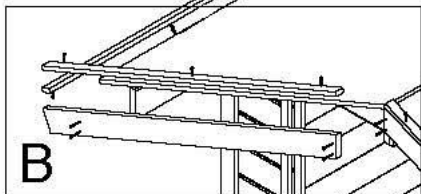
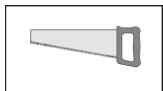

B

A

A

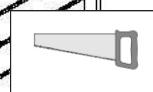

B

POS12

POS11

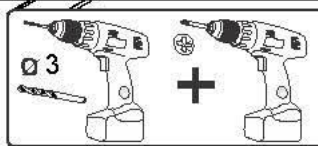

3,5x25mm

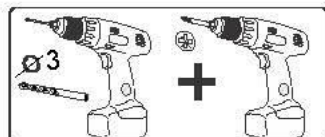

3,5x35mm



13

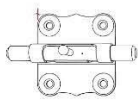
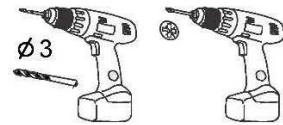
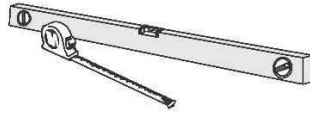

4X

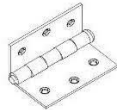

4X



14X

3,5x35mm

POS

6. 408x1250mm 2X

15. 30x30x240mm 1X



3.5x30mm

16X

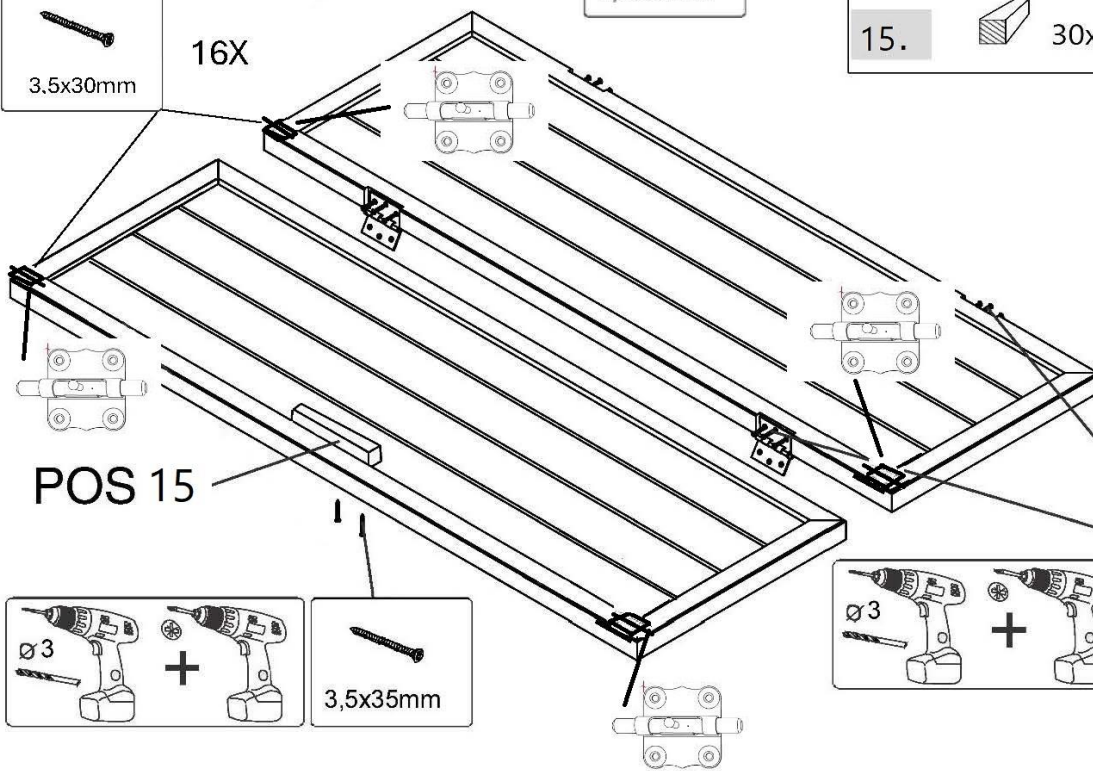

POS 15

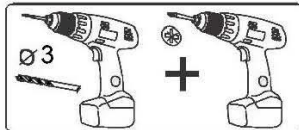

∅3

+



3,5x35mm

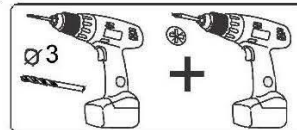

∅3

+



3,5x35mm

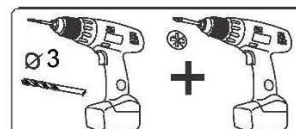
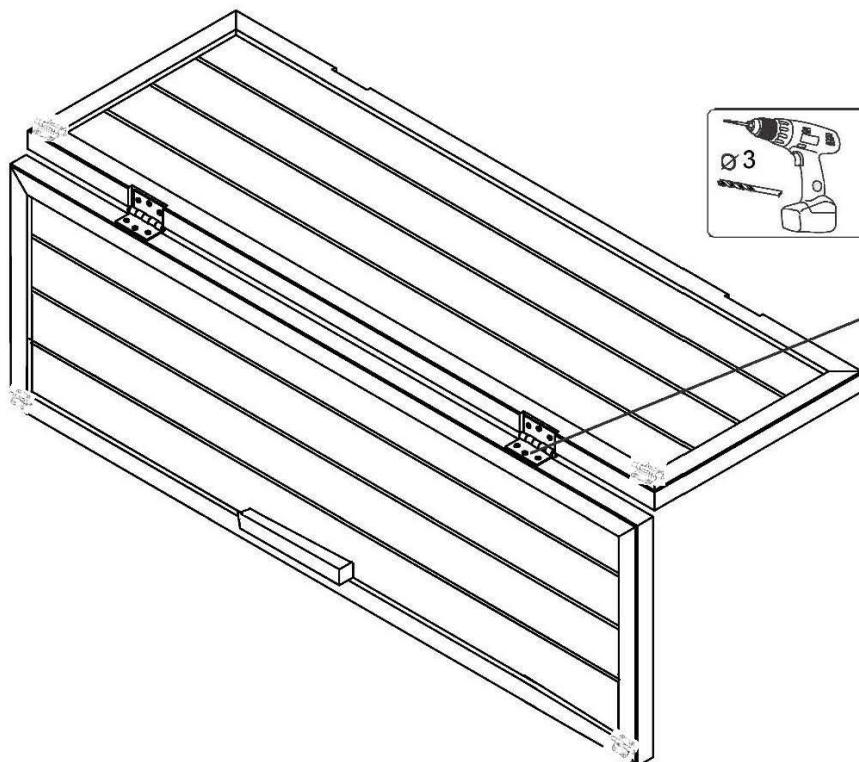

∅3

+



3,5x35mm

14

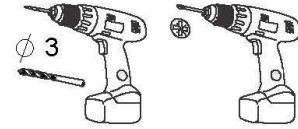

3,5x35mm

24X

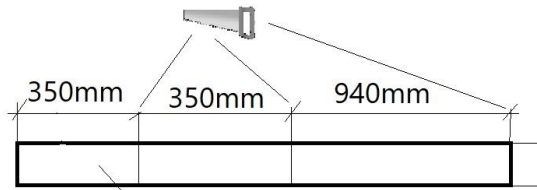

POS 13

POS

13. 15x45x1780 2X

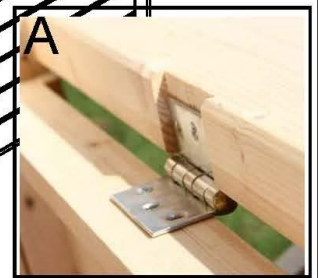
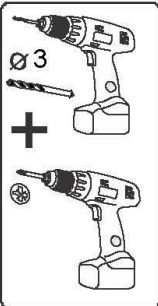
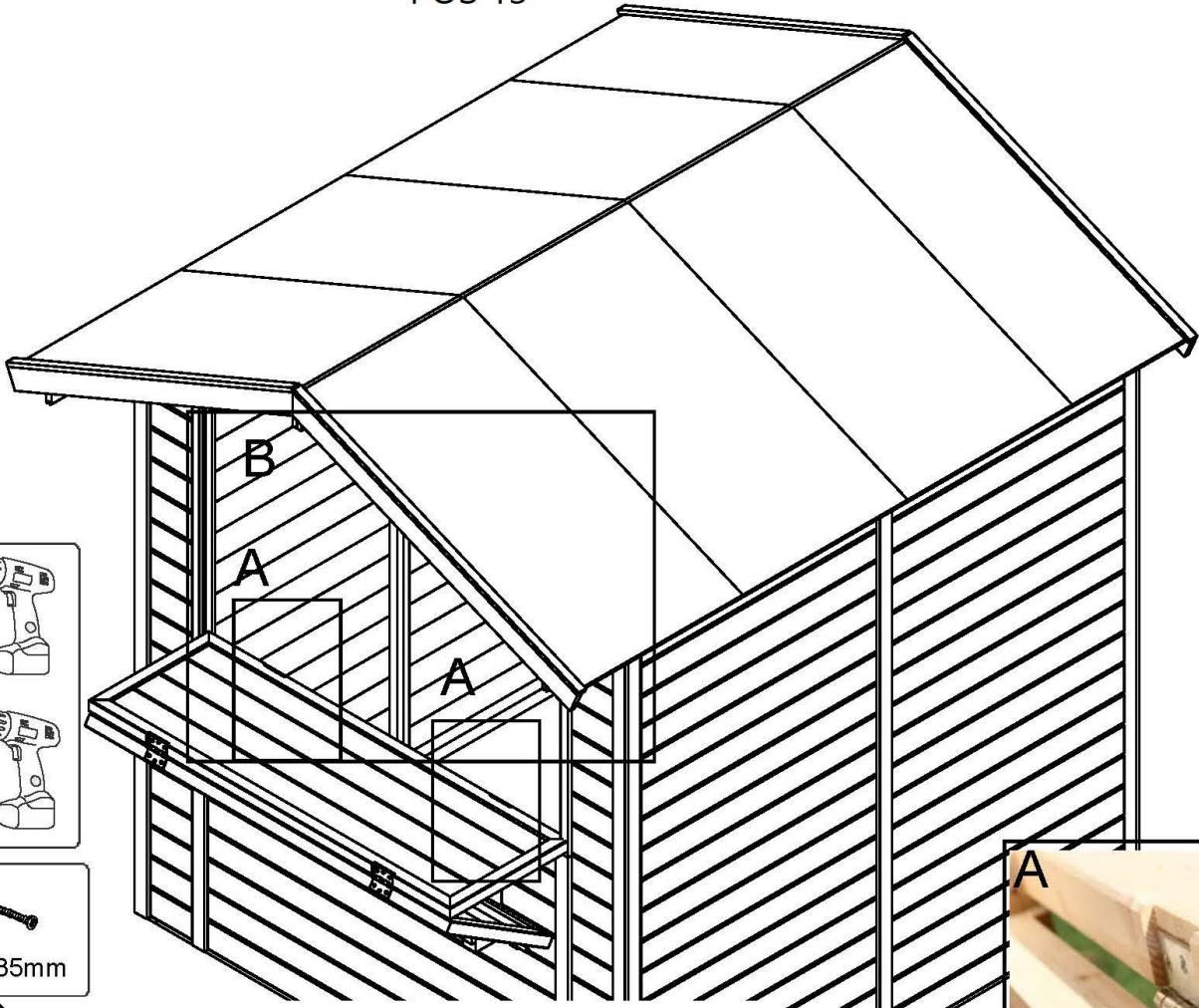

B

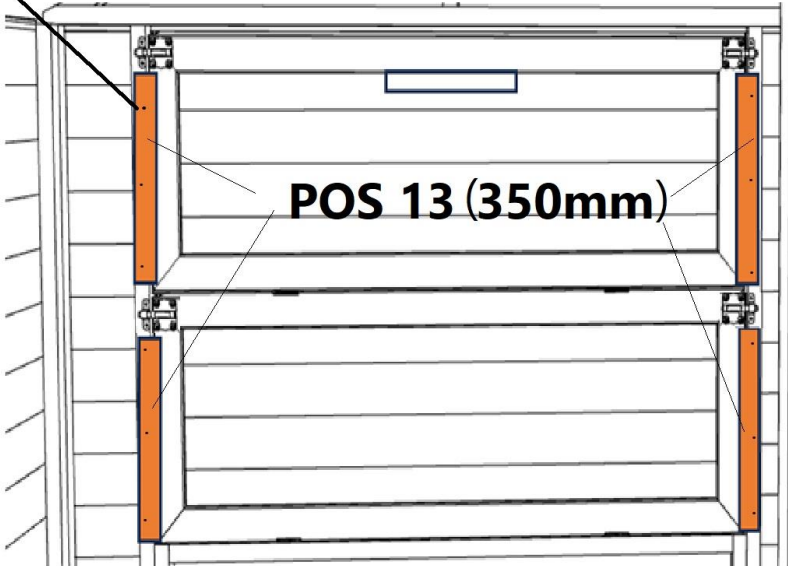

POS 13 (350mm)

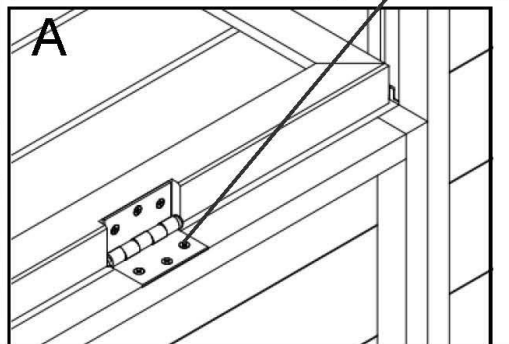
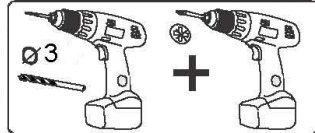



15

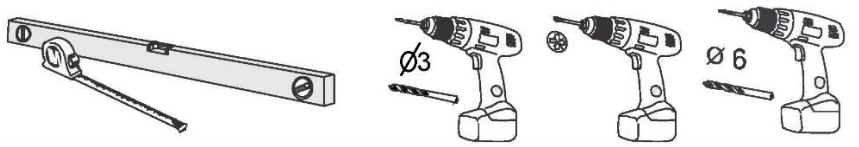

3,5x30mm 26X

4,0x60mm 4X

POS			
13.		14x45x1780mm	3 X
14.		14x25x914mm	1X
15.		30x30x240mm	2X
17.		908x1780mm	1X

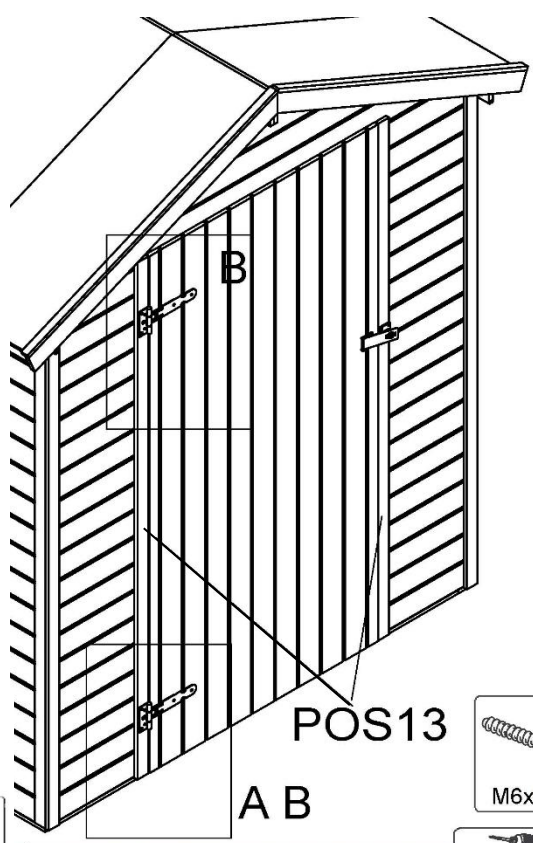
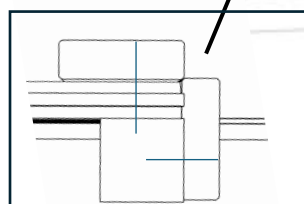
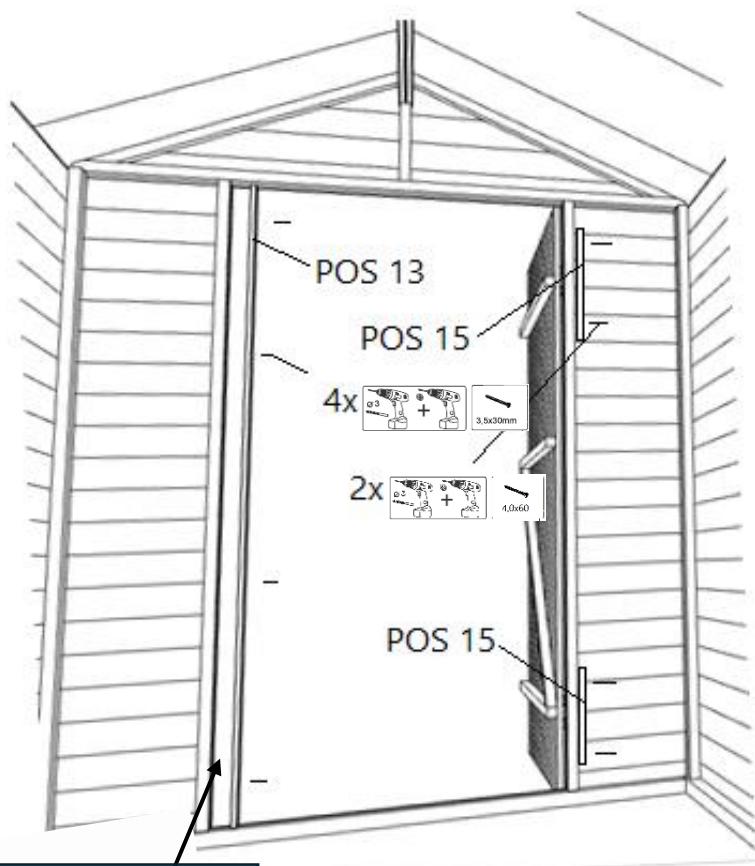

+ 3,5x30mm

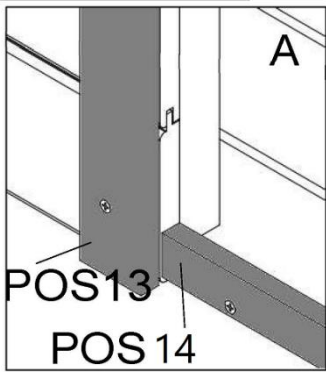

3,5x30mm

+

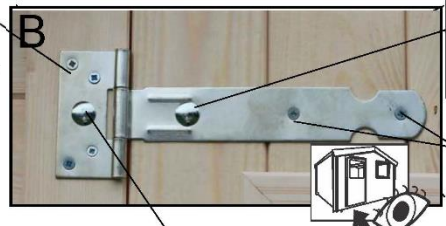

M6x60mm

$\varnothing 6$

3,5x30mm

$\varnothing 6$  M6x 70mm

+

16



7X

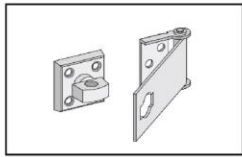

1X

