



Tisch/Borte

Linea I

Montageanleitung

Stand: 01.05.2015



Montageanleitung

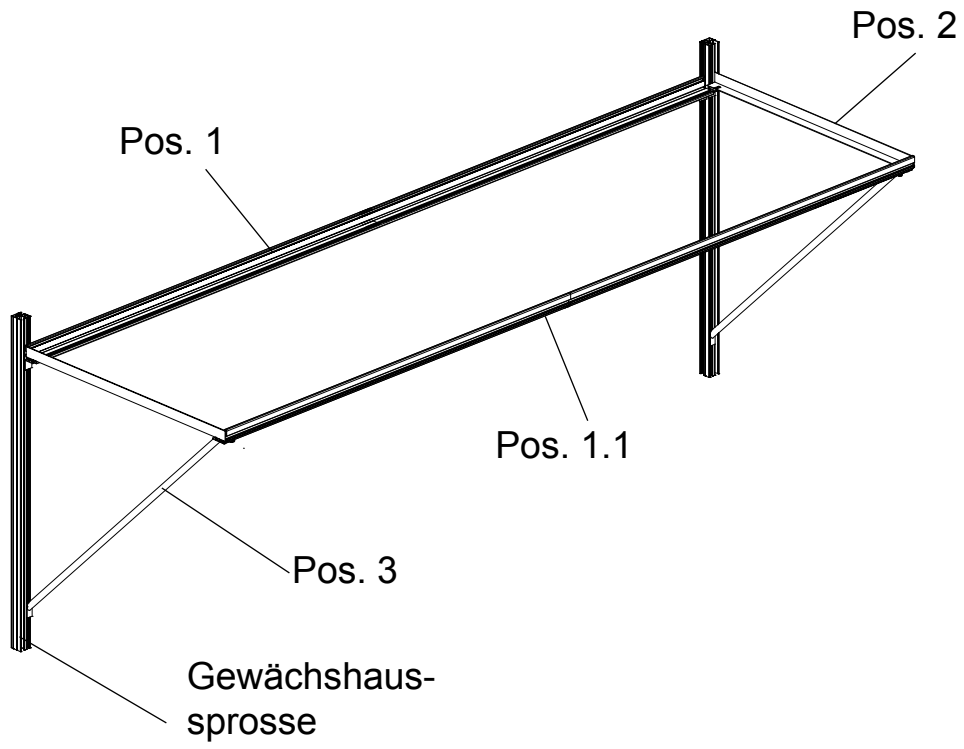

Schritt 1

zu Schritt 1



Die Endstücke Strebe (V36) jeweils am Ende der Streben (Pos. 3) aufstecken.

Schritt 2

zu Schritt 2



In den unteren Kanal, auf der Innenseite der Längsprofile (Pos. 1/1.1) ziehen Sie pro Gewächshausprosse eine Sechskantschraube M6 x 16 vom Ende her ein.

Schritt 3

zu Schritt 3

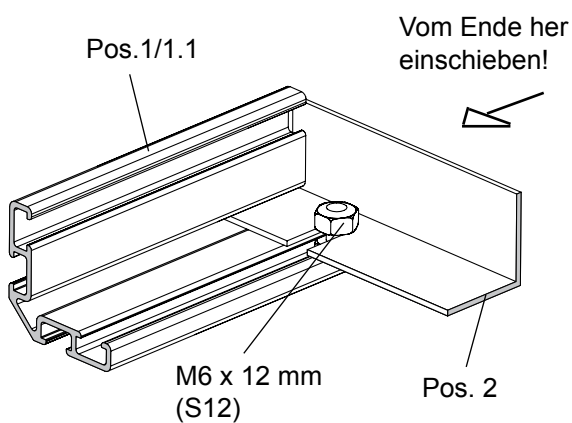

Das Querprofil (Pos. 2) vom Ende her einschieben und verschrauben.



Schritt 4



zu Schritt 4

Tisch/Borte an den Gewächshaus-
sprossen verschrauben. Hierzu die
Streben (Pos. 3) und die Auflegewinkel
(V185) an den Sprossen mit Hilfe der
Hammerkopfschrauben
M6 x 16 (S15) anschrauben.

Ansicht

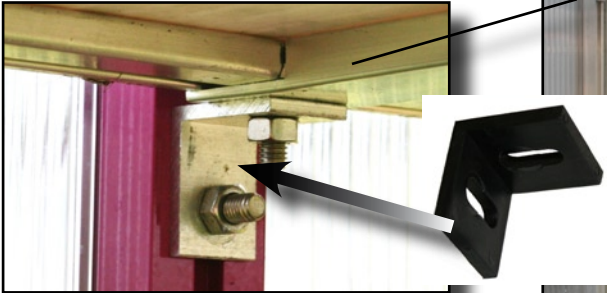

Schritt 5





zu Schritt 5

Einlegen der Tisch- und Bortenplatten.

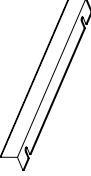
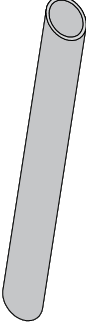

Modell Linea I

Stückliste Tisch/Borte

Bezeichnung	Pos.-Nr.	Art.-Nr.	Darstellung	Linea I
Längsprofil	1/1.1			2 1046
Querprofil	2			2
Strebe	3			2
Endstück Strebe	V36	9999 0015		4
Auflgewinkel 4 mm	V185			2

Modell Linea I

Stückliste Tisch/Borte

Bezeichnung	Pos.-Nr.	Art.-Nr.	Darstellung	Linea I
Sechskantschraube M6 x 12 mit Mutter M6	S12 S1	9999 0124 9999 0128		4
Sechskantschraube M6 x 16 mit Mutter M6	S5 S1	9999 0183 9999 0128		4
Hammerkopfschraube M6 x 16 mit Mutter M6	S15 S1	9999 0063 9999 0128		4