

VERRIÈRE / INTERNAL GLASS WINDOW / GLASTRENNWAND / BINNENRAAM

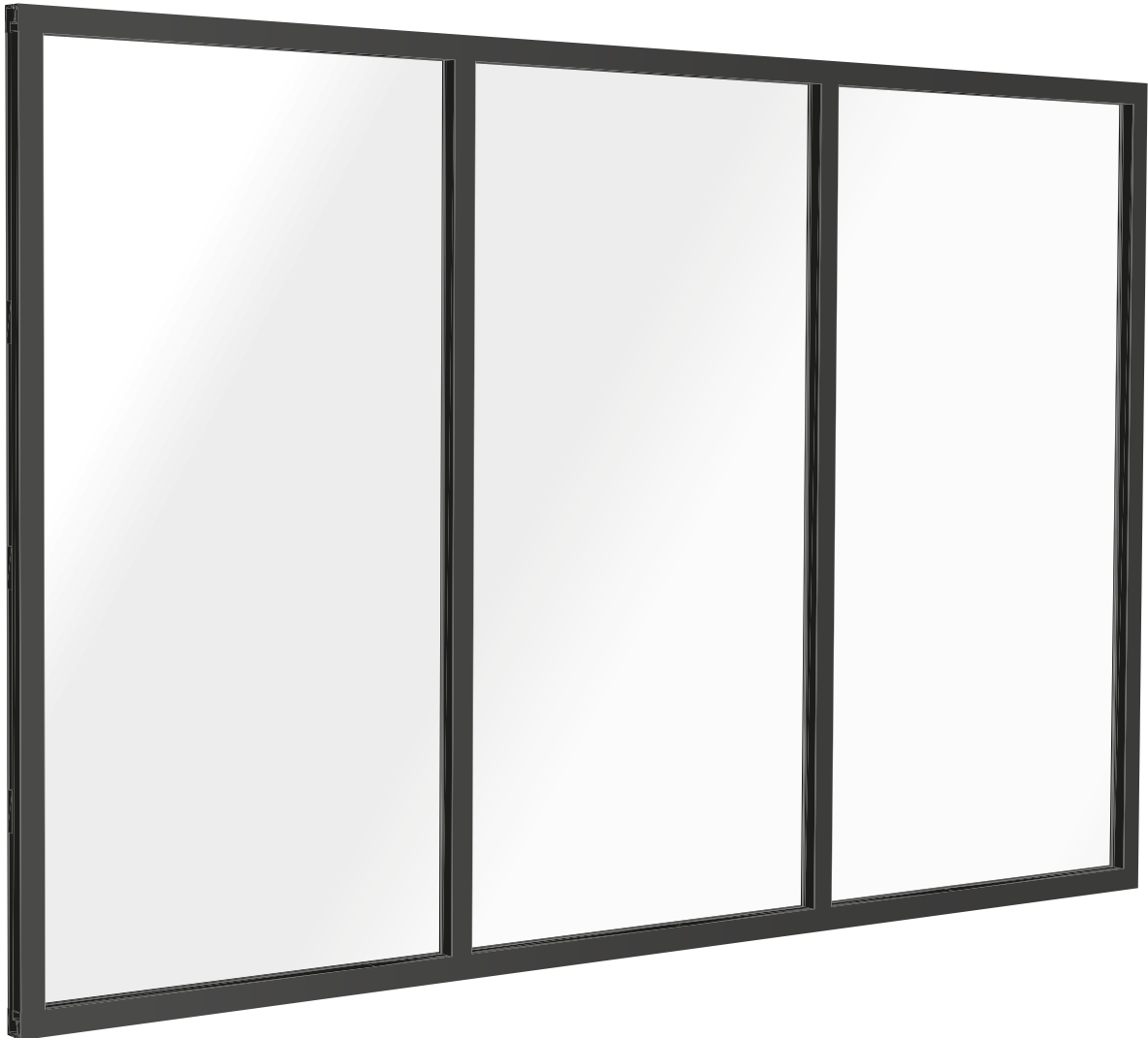

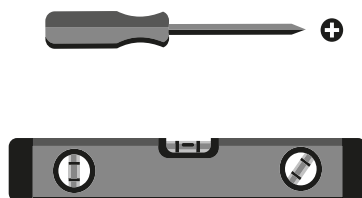

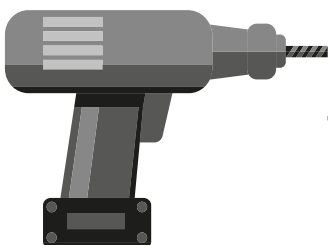

Ces instructions de montage s'appliquent à tous les modèles de verrière.
These assembly instructions apply to all glass windows.
 Montageanleitung gilt für alle Glastrennwand-Ausführungen.
 Deze plaatsingsinstructies gelden voor alle modellen binnenramen.

MATÉRIEL NÉCESSAIRE / NEEDED TOOLS / BENÖTIGTE WERKZEUGE / BENODIGD GEREEDSCHAP
 (non fourni / not provided / nicht im Lieferumfang enthalten / niet meegeleverd)

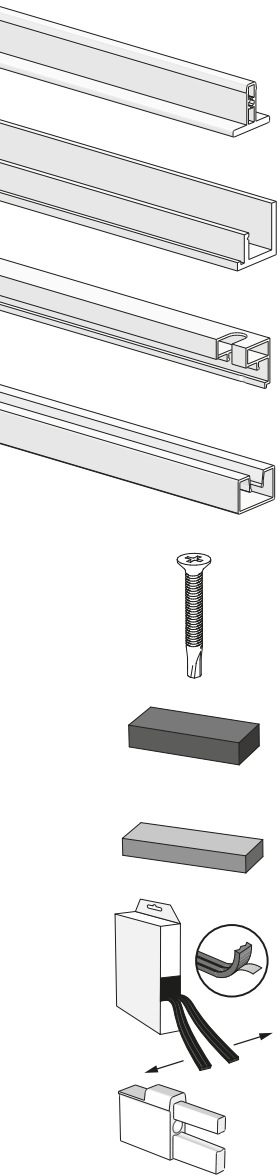

COMPOSITION DE VOTRE COLIS / INCLUDED IN THE PACKAGE /
 PACKETINHALT / INHOUD VAN DE VERPAKKING



		x1	x2	x3	x4
					
A	Profil Profile Profil Profiel	x2	x3	x4	x5
B	Profil Profile Profil Profiel	x2	x2	x2	x2
C	Profil Profile Profil Profiel	x2	x2	x2	x2
D	Profil Profile Profil Profiel	x2	x3	x4	x5
E	Vis Screw Schraube schroef	x4	x6	x8	x10
F	Mousse adhésive Adhesive foam Klebschaum Zelfklevend schuim	x6	x6	x6	x6
G	Grande cale Large wooden block Großer Holzblock Grote houten blok	x2	x4	x6	x8
H	Joint adhésif Adhesive gasket Klebedichtung Zelfklevende afdichting	6m x2	6m x4	6m x6	6m x8
i	Insert Insert Verbindungsstück Invoegen	x4	x6	x8	x10

ÉTAPE 1 - STEP 1 - SCHRITT 1 - STAP 1

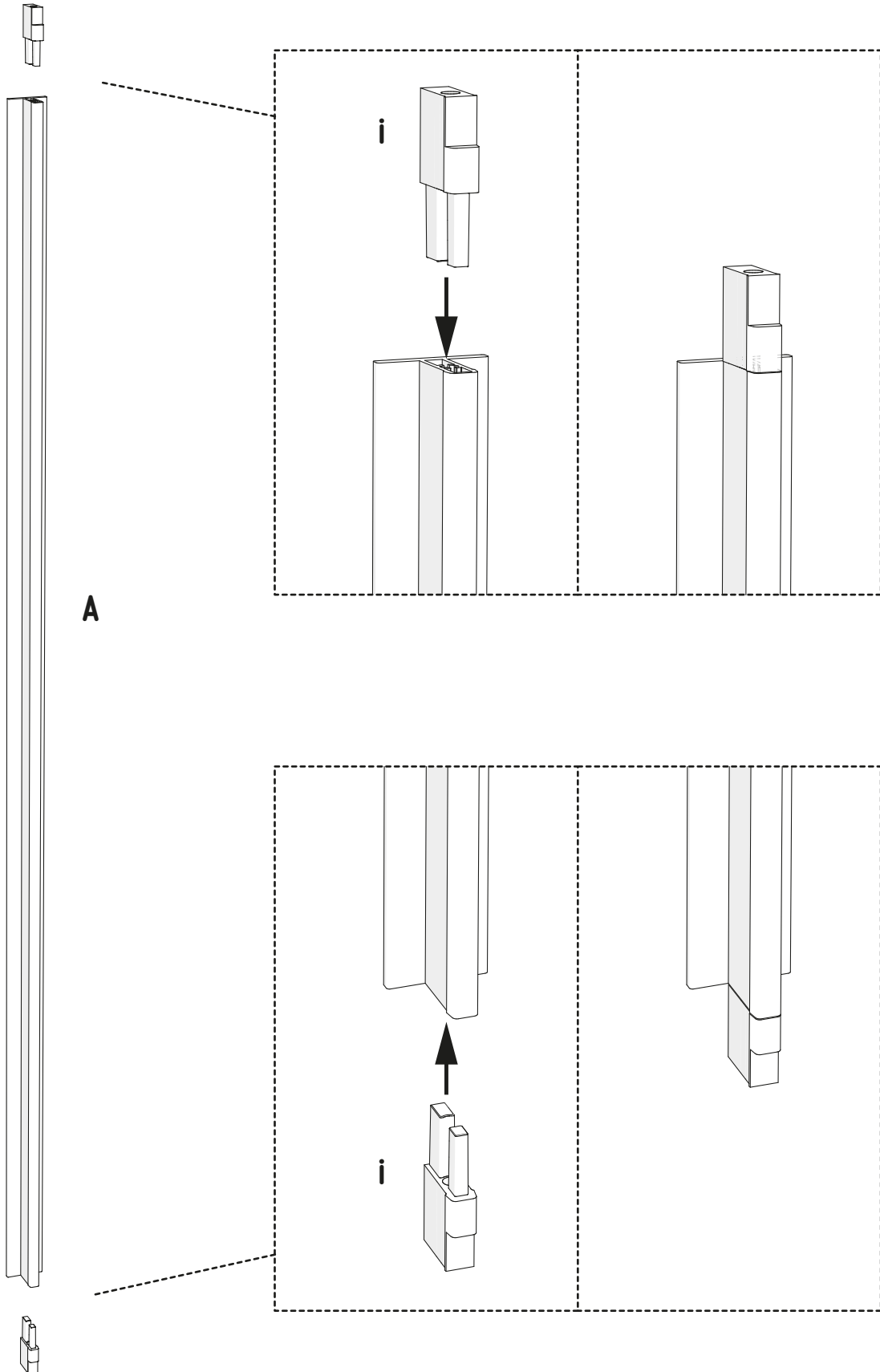

ÉTAPE 2 - STEP 2 - SCHRITT 2 - STAP 2

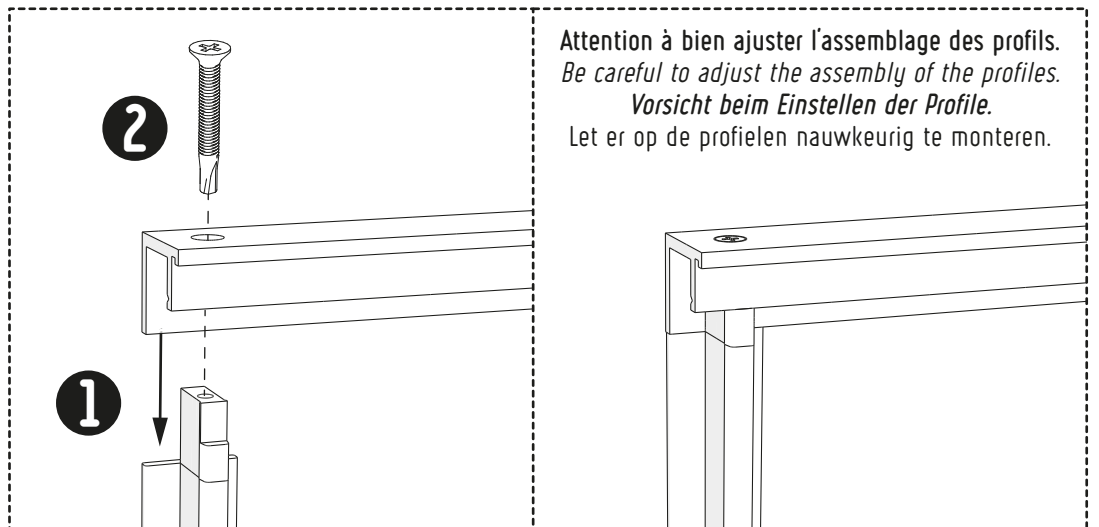
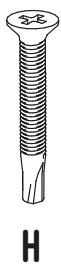
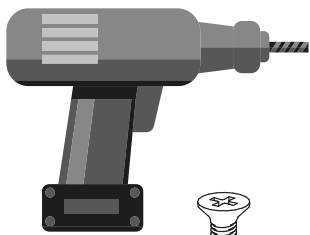
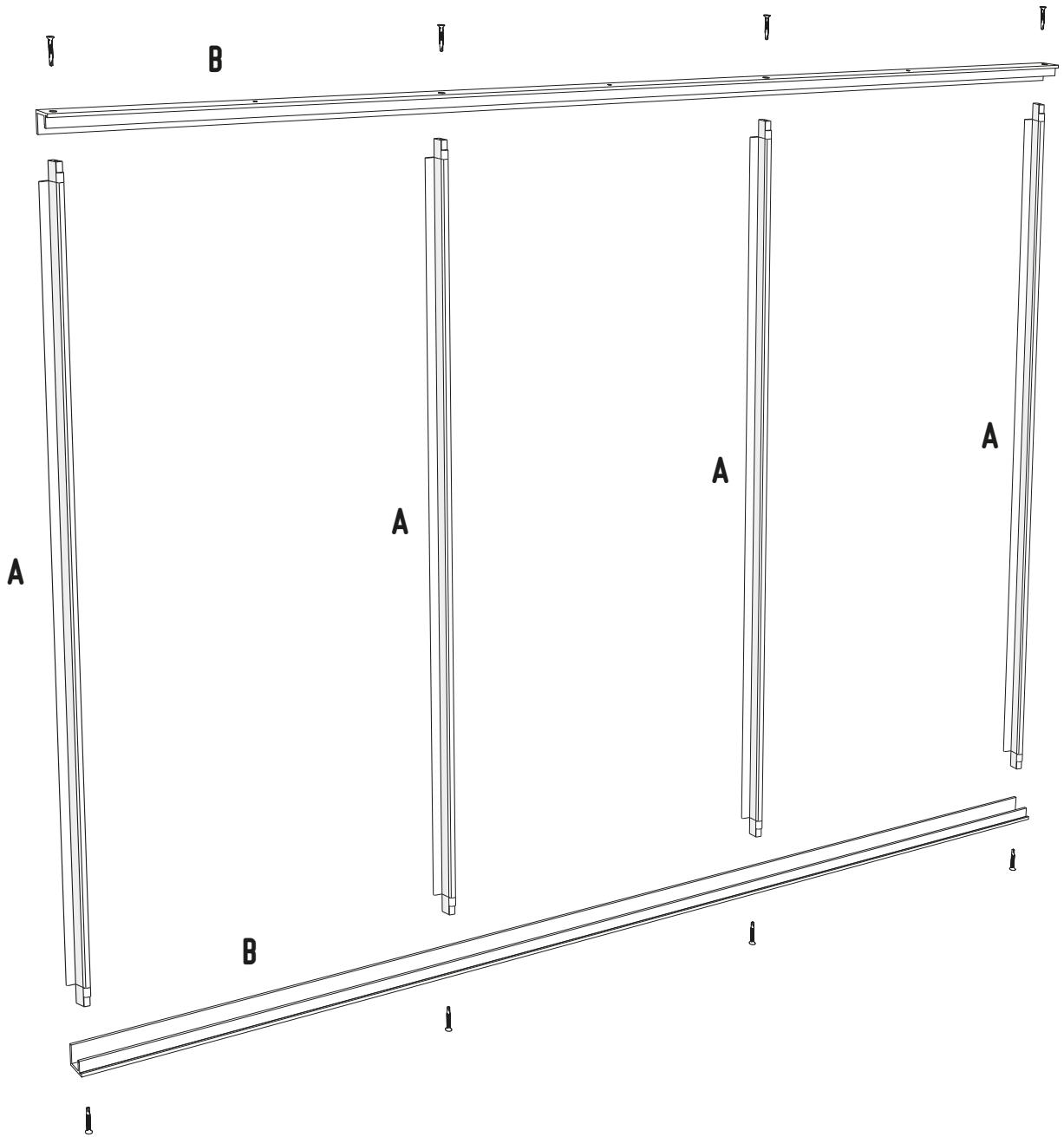

ÉTAPE 3 - STEP 3 - SCHRITT 3 - STAP 3

FR

Pour l'installation d'un poteau d'angle ou d'un poteau de terminaison, suivez la notice présente sur leur emballage. (Installation à effectuer avant la pose des mousses adhésives).

EN

To install the corner profile or the angle profile, please follow the instructions mentioned on the packaging. (installation to be done before the application of the adhesive foams).

DE

Zur Montage des Eckprofils oder des Abschlussprofils die Anweisungen auf der entsprechenden Verpackung beachten. (Vor dem Anbringen des Klebeschaums, müssen die Profile vorab montiert werden).

NL

Voor de installatie van een hoekprofiel of een eindprofiel, volg de instructies op de verpakking. (installeren vóór de plaatsing van de schuimblokjes)

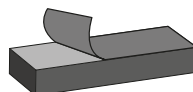
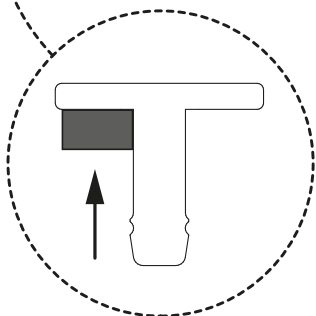
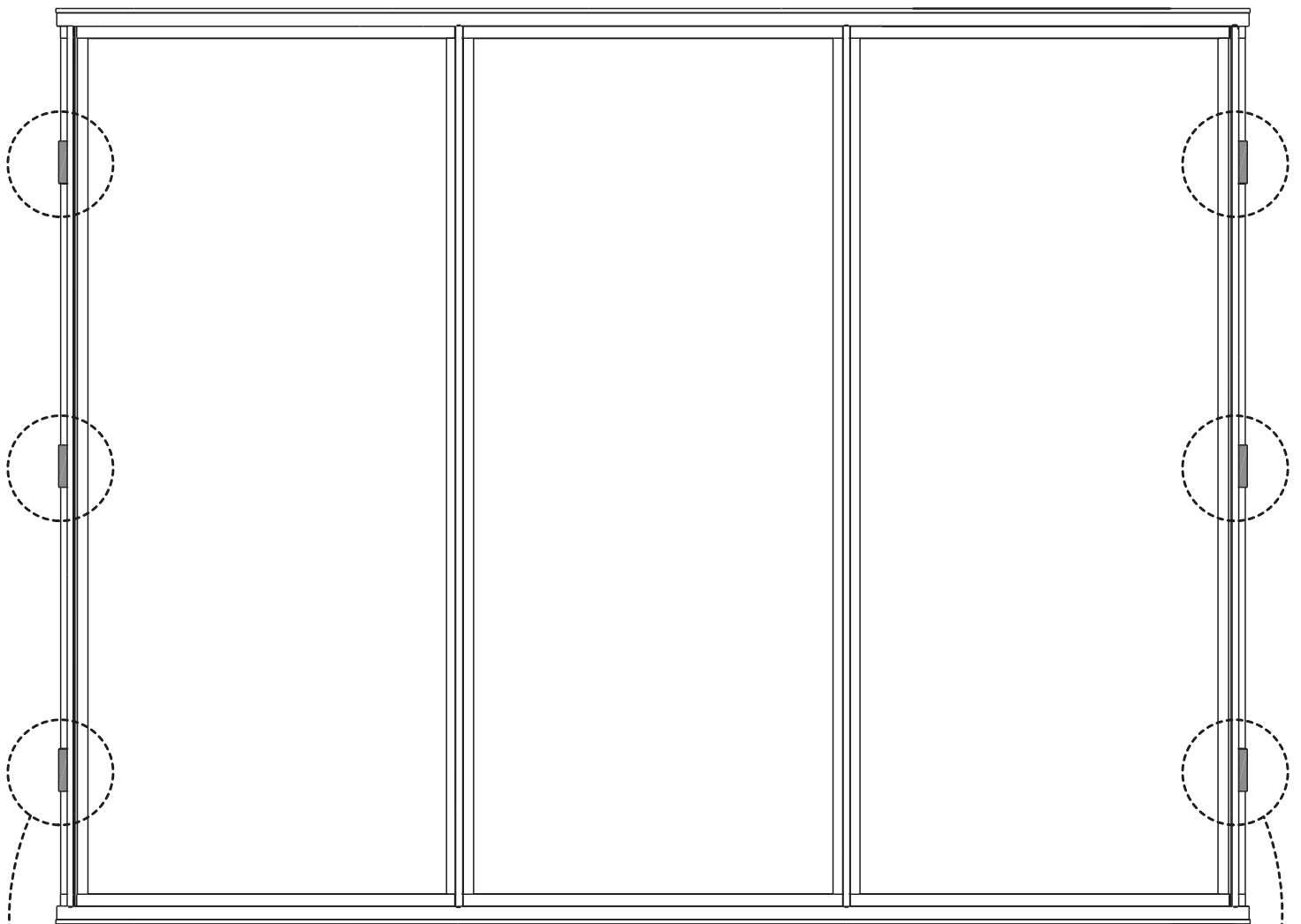
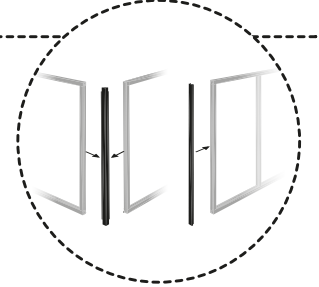

F

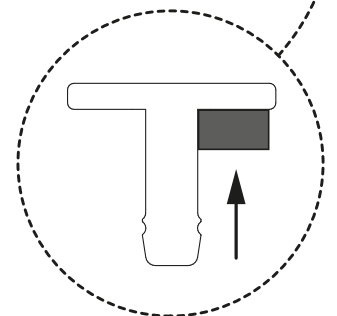

ÉTAPE 4 - STEP 4 - SCHRITT 4 - STAP 4

MUR / WALL / MAUER / MUUR

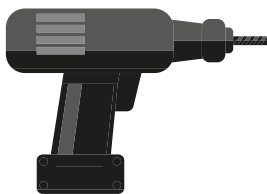
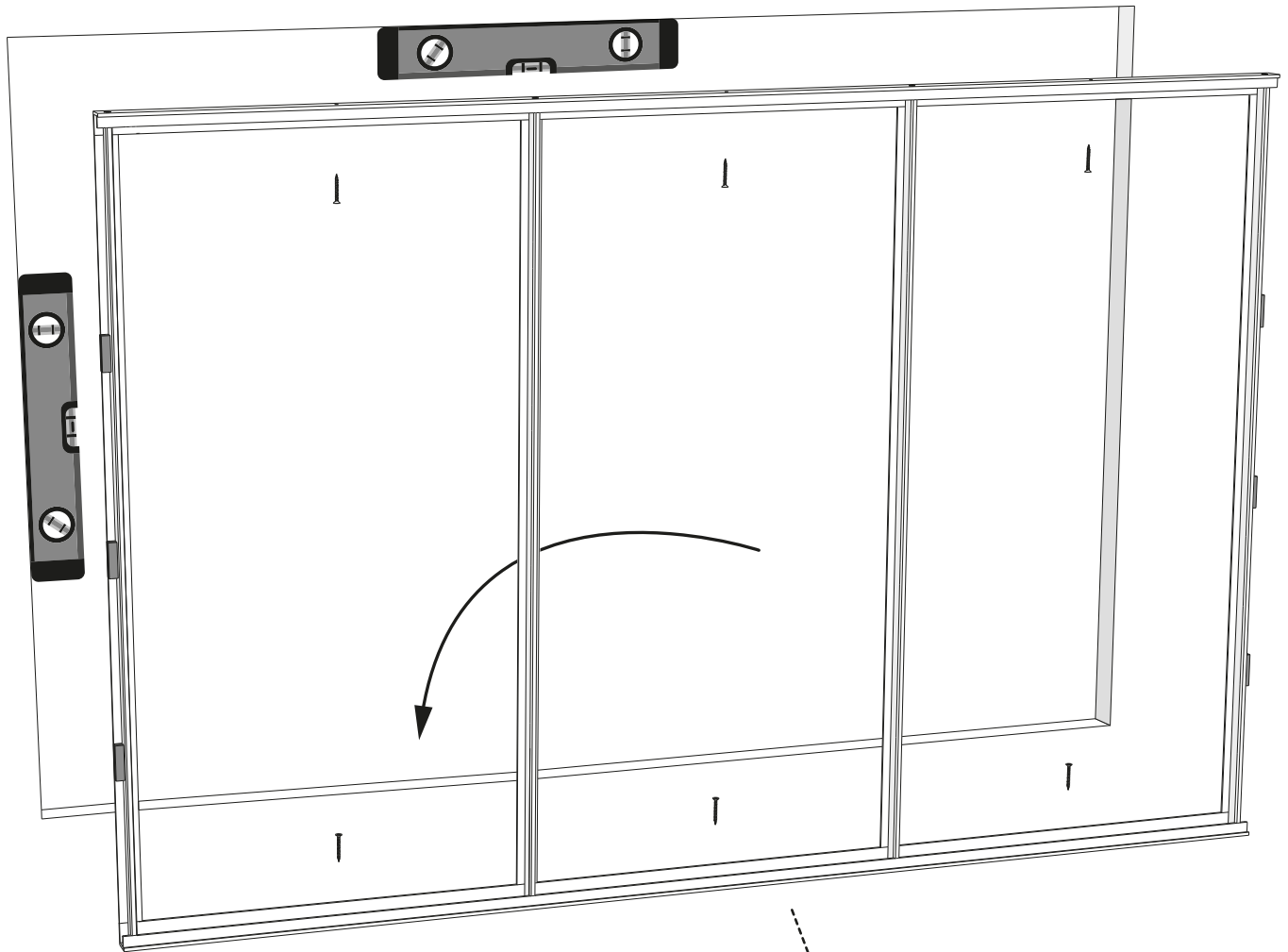

Vis (non fournies)
à adapter selon votre support.

Screw (not provided)
to adapt accordingly to your support.

Schrauben nicht im Lieferumfang enthalten.
Befestigung entsprechend dem Träger
(Holz, Beton, usw.) verwenden.

Schroeven (niet meegeleverd)
aan te passen volgens de wand.

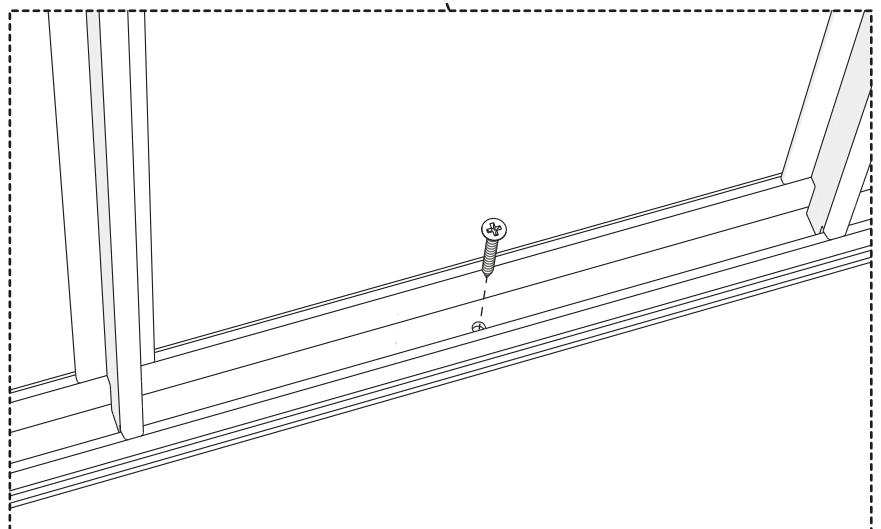

ÉTAPE 5 - STEP 5 - SCHRITT 5 - STAP 5

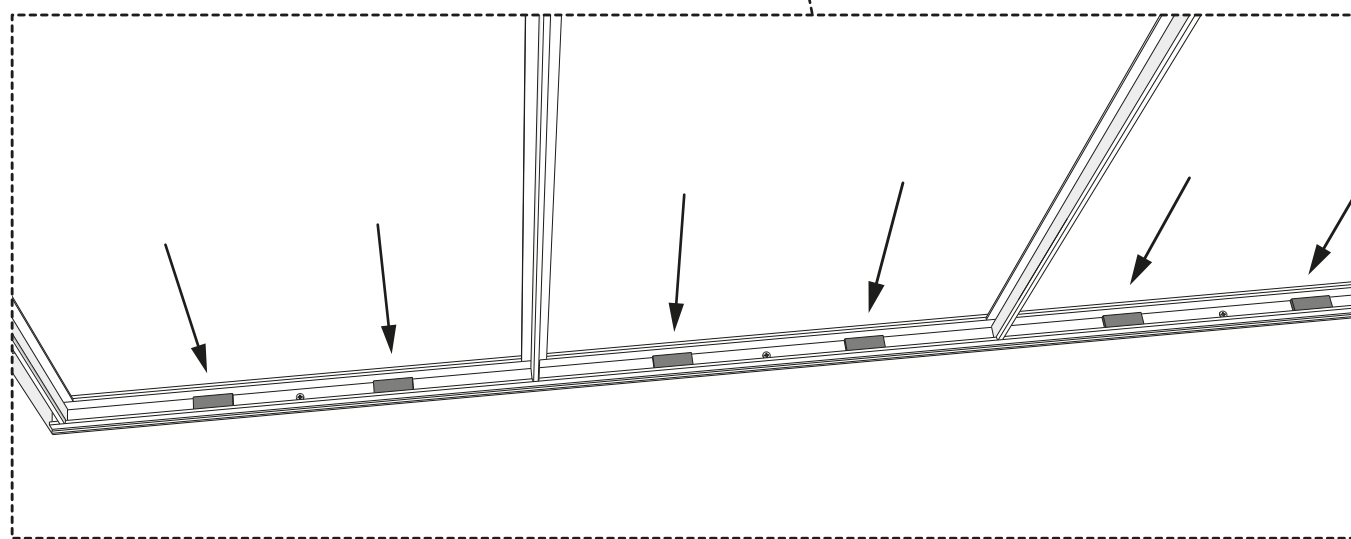
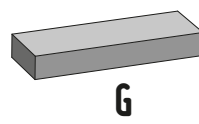
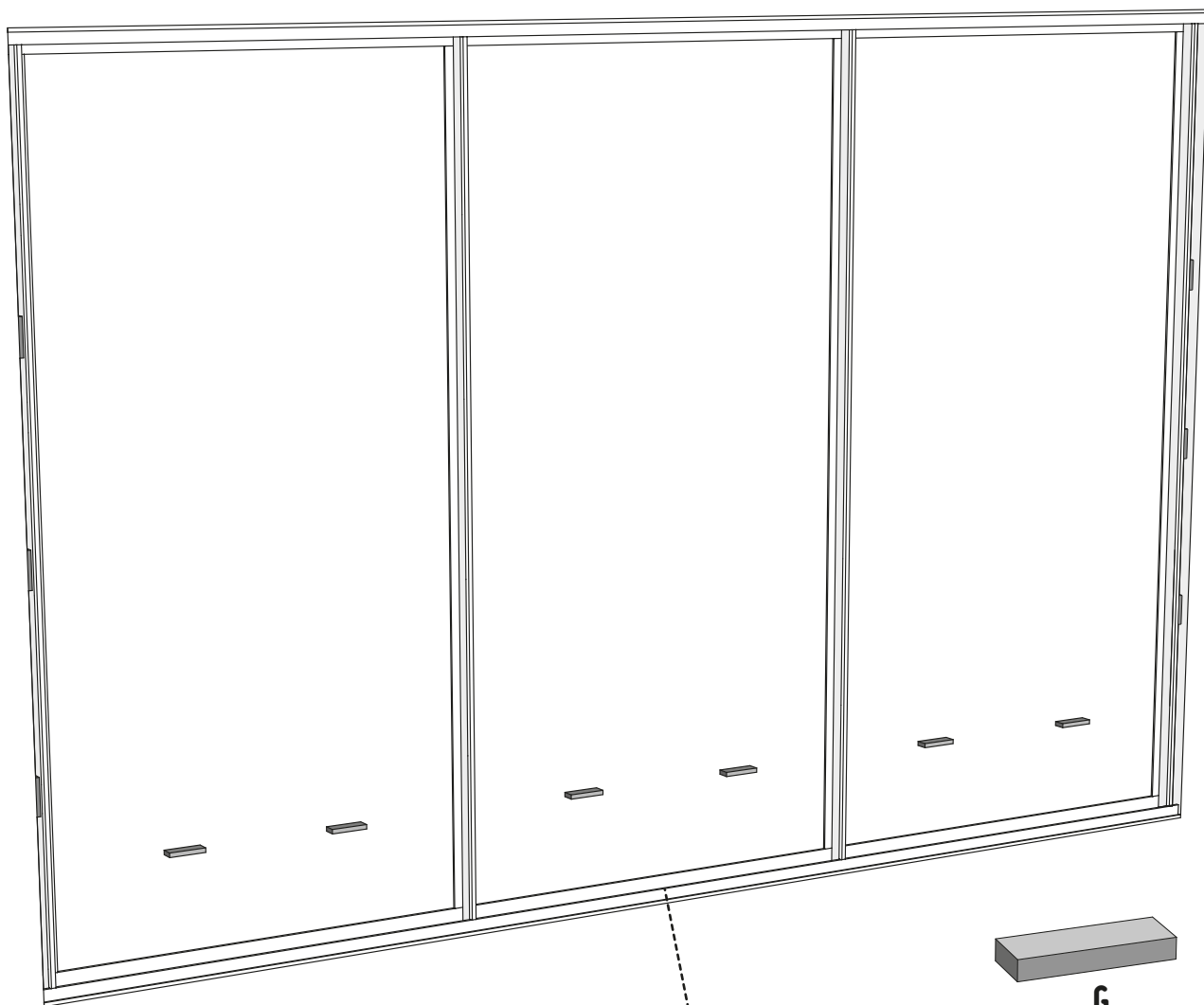

ÉTAPE 6 - STEP 6 - SCHRITT 6 - STAP 6

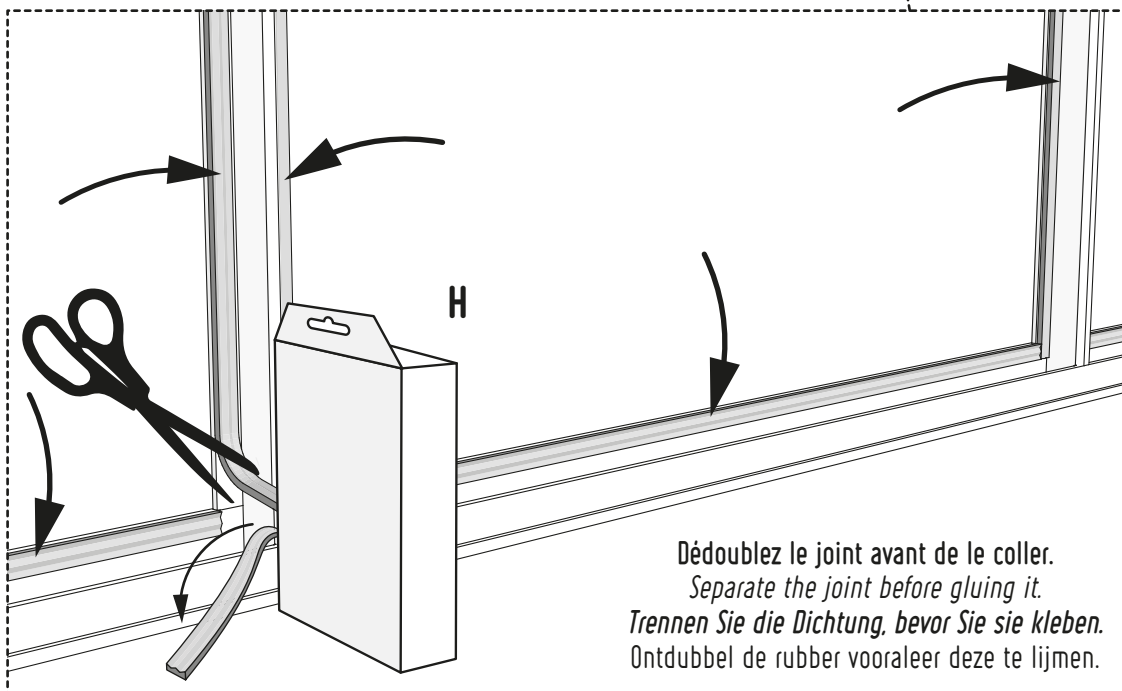
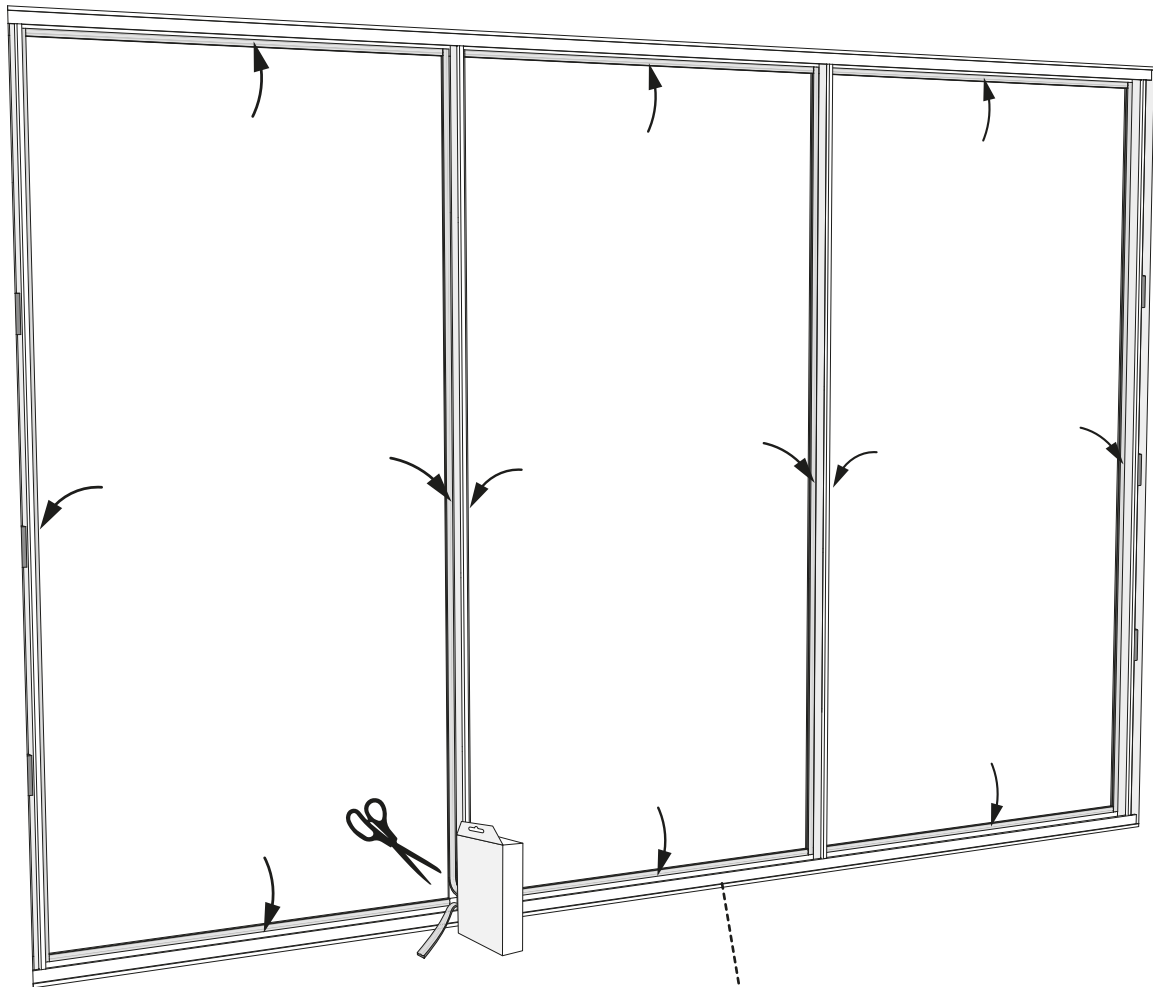

Alignement
Alignment
Ausrichtung
Uitlijning

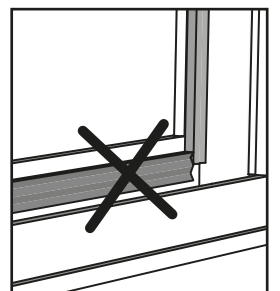
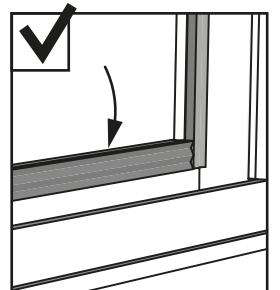

ÉTAPE 7 - STEP 7 - SCHRITT 7 - STAP 7

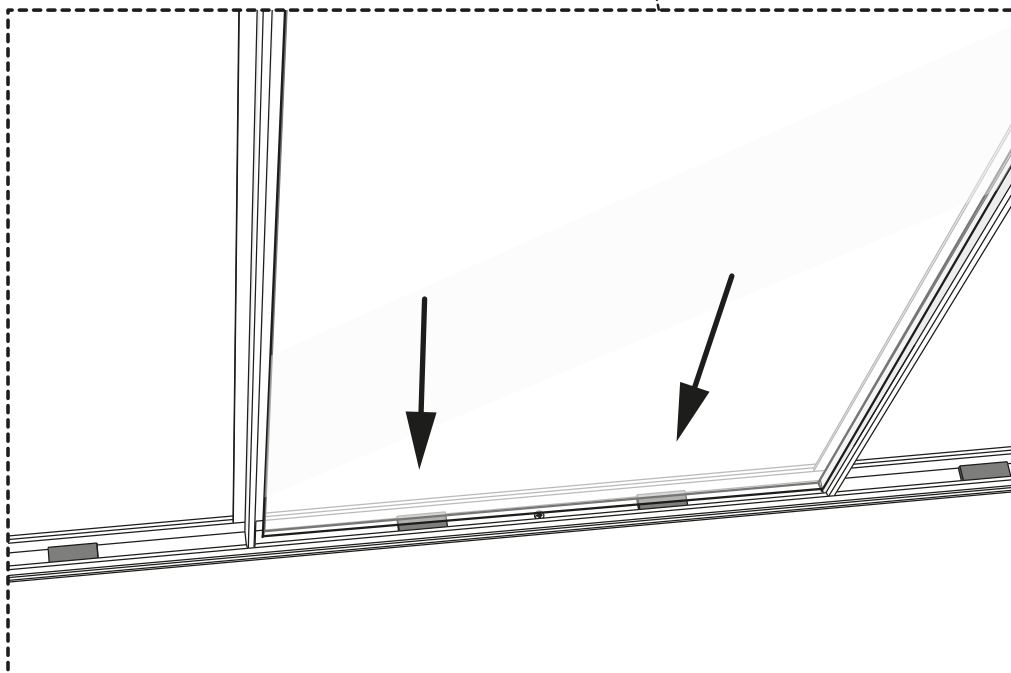
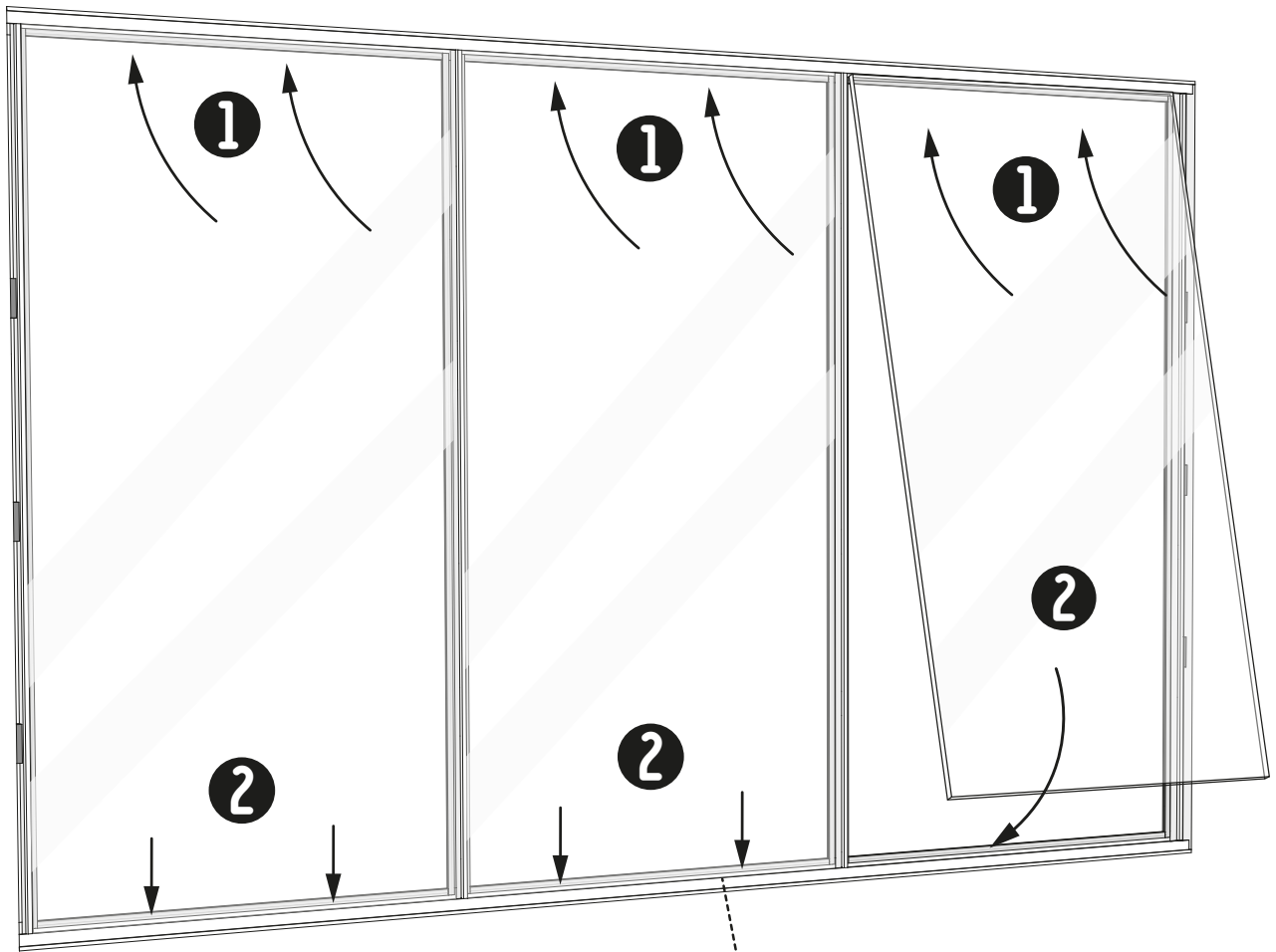

ÉTAPE 8 - STEP 8 - SCHRITT 8 - STAP 8

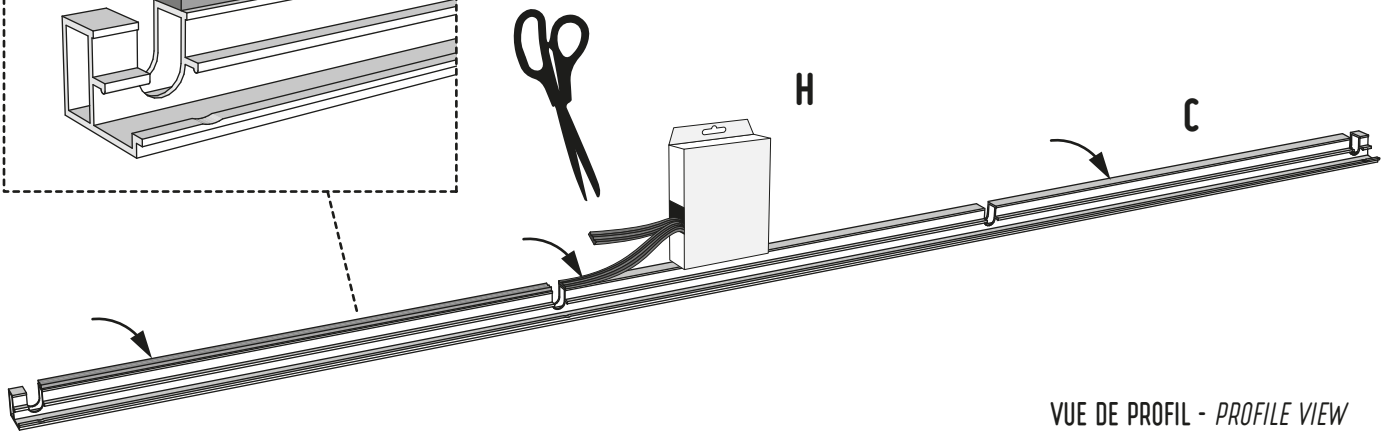
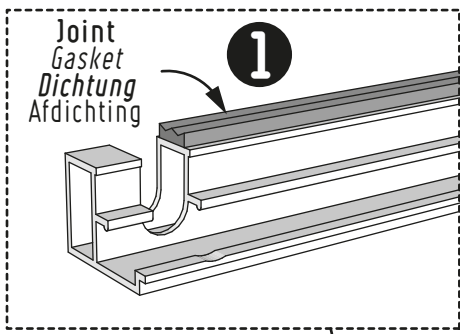

VUE DE PROFIL - PROFILE VIEW
PROFILANSICHT - ZIJAANZICHT

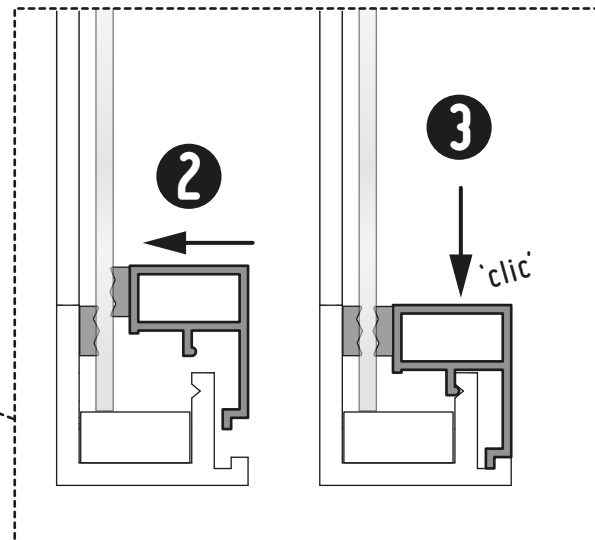
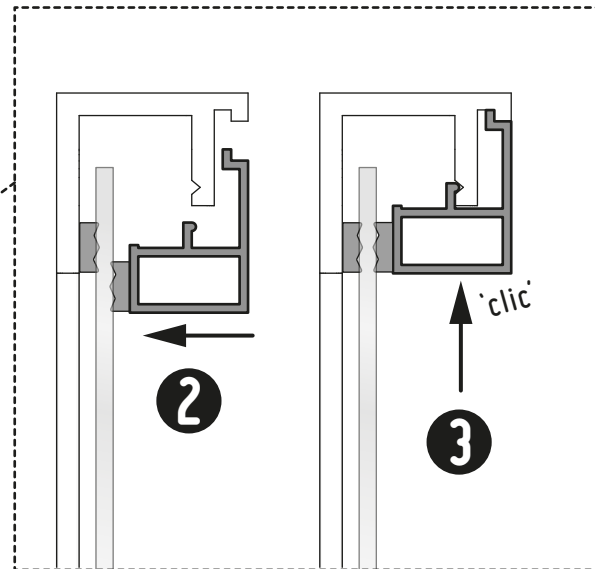
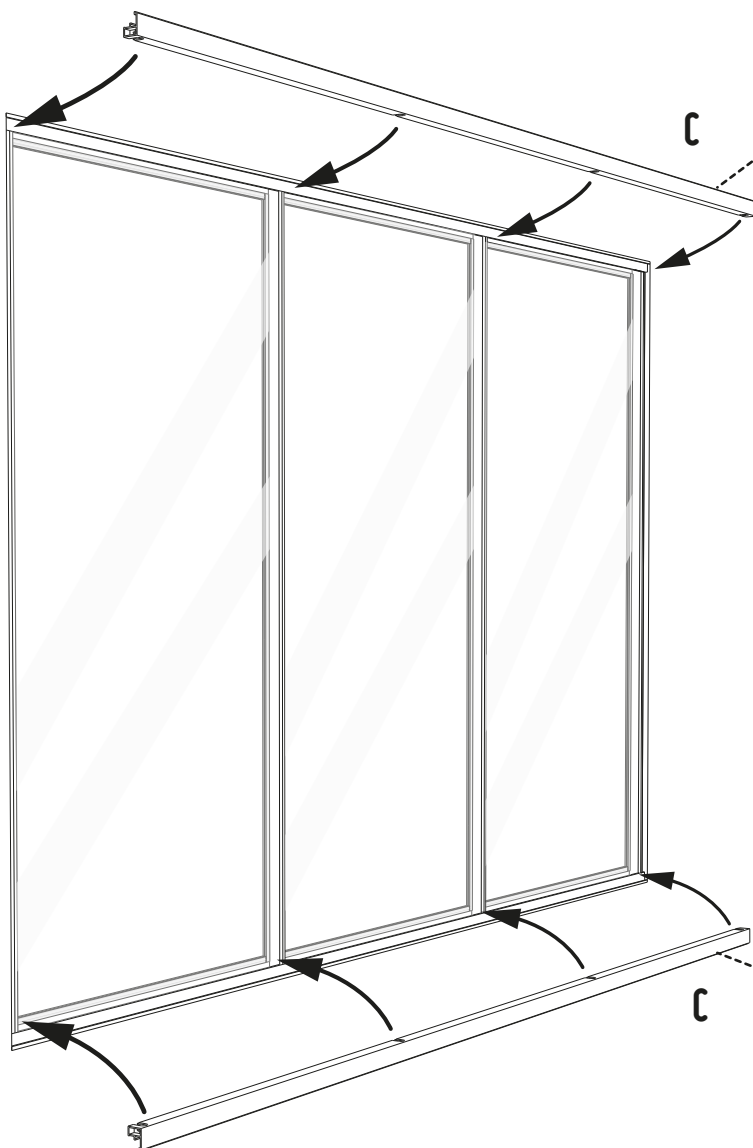

ÉTAPE 9 - STEP 9 - SCHRITT 9 - STAP 9

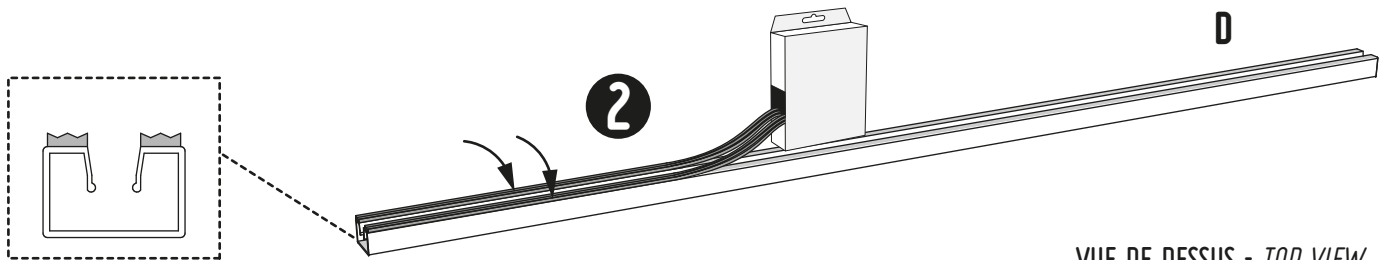
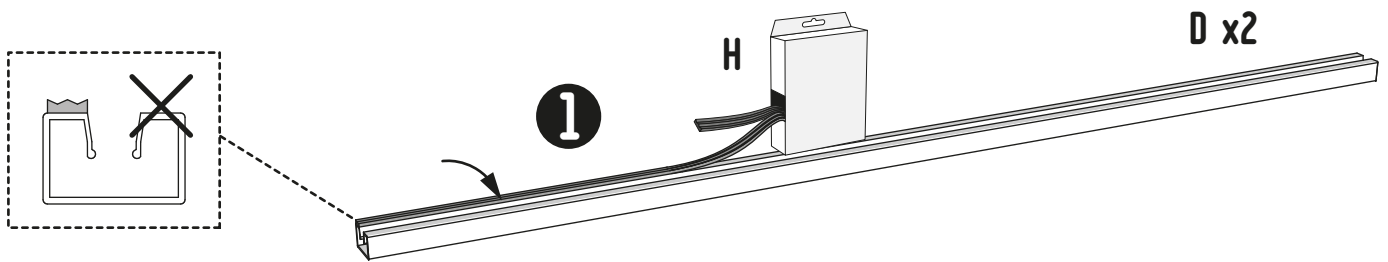

VUE DE DESSUS - TOP VIEW
ANSICHT VON OBEN - BOVENAANZICHT

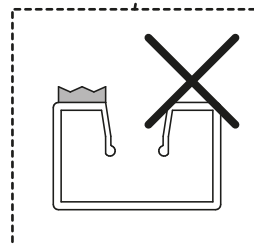
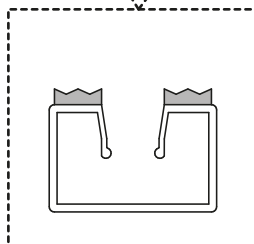
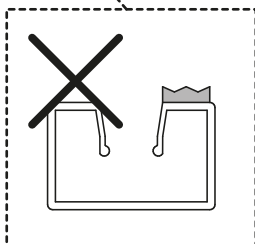
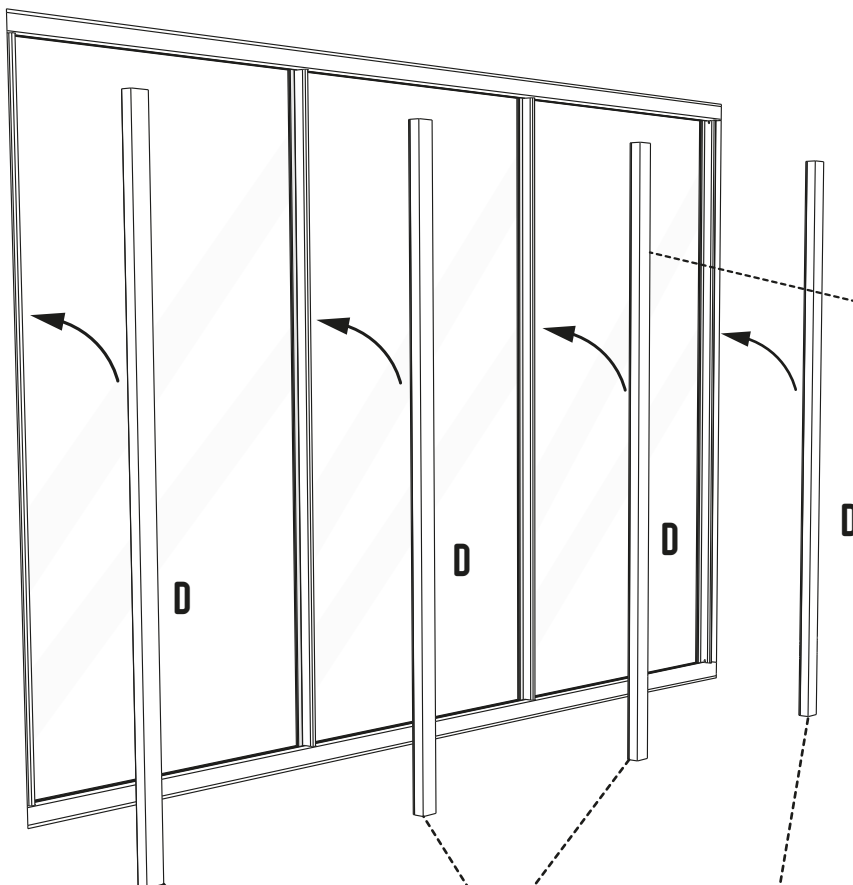
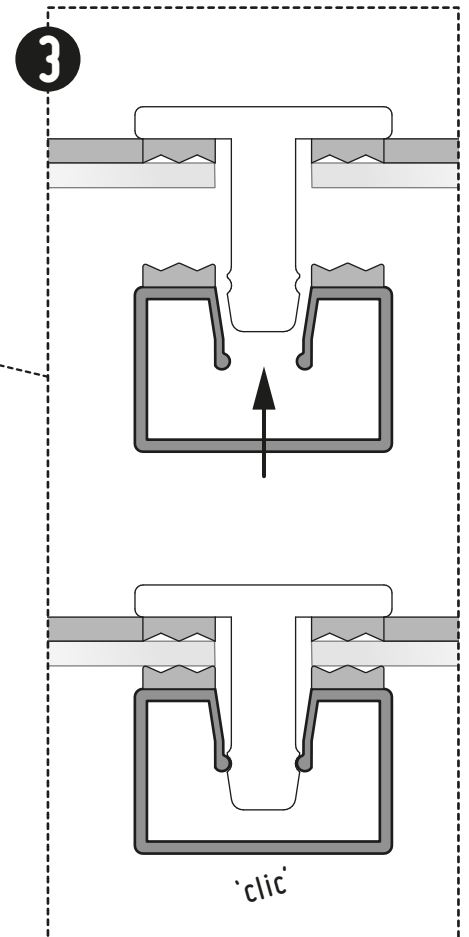

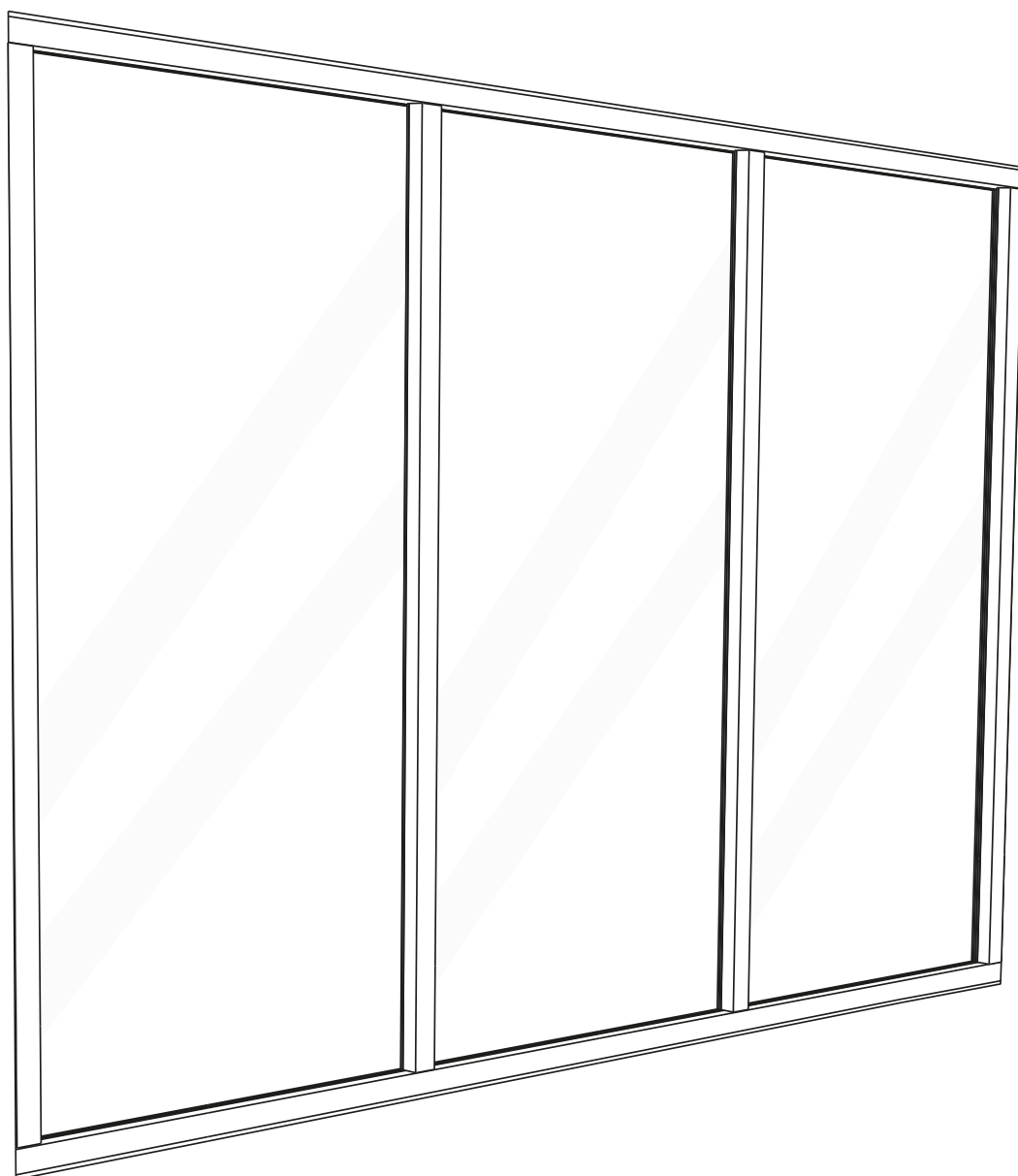

Félicitations ! *Congratulations ! Herzliche Glückwünsche!* Gefeliciteerd!