



● steinel



NightmatIQ
NightmatIQ Plus

DE

GB

FR

NL

IT

ES

PT

SE

DK

FI

NO

GR

TR

Inhalt

1.	Zu diesem Dokument	3
2.	Allgemeine Sicherheitshinweise	3
3.	Gerätebeschreibung	4
4.	Elektrischer Anschluss	9
5.	Montage	10
6.	Funktion	19
7.	Reinigung und Pflege	24
8.	Entsorgung	24
9.	Herstellergarantie	25
10.	Technische Daten	27
11.	Störungsbehebung	28

1. Zu diesem Dokument

- Urheberrechtlich geschützt. Nachdruck, auch auszugsweise, nur mit unserer Genehmigung.
- Änderungen, die dem technischen Fortschritt dienen, vorbehalten.



Warnung vor Gefahren!



Warnung vor Gefahren durch Strom!



Warnung vor Gefahren durch Wasser!

2. Allgemeine Sicherheitshinweise



Gefahr durch Nichtbeachtung der Gebrauchsanleitung!

Diese Anleitung enthält wichtige Informationen für den sicheren Umgang mit dem Gerät. Auf mögliche Gefahren wird besonders hingewiesen. Die Nichtbeachtung kann zu Tod oder schweren Verletzungen führen.

- Anleitung sorgfältig lesen.
- Sicherheitshinweise befolgen.
- Zugänglich aufbewahren.
- Der Umgang mit elektrischem Strom kann zu gefährlichen Situationen führen. Die Berührung von stromführenden Teilen kann zu elektrischem Schock, Verbrennungen oder Tod führen.
- Die Arbeit an der Netzspannung ist nur durch qualifiziertes Fachpersonal zulässig.
- Landesübliche Installationsvorschriften und Anschlussbedingungen sind zu beachten (z. B. D: VDE 0100, A: ÖVE-ÖNORM E8001-1, CH: SEV 1000).
- Nur Original-Ersatzteile verwenden.
- Reparaturen sind nur durch Fachbetriebe zulässig.

3. Gerätebeschreibung

Bestimmungsgemäßer Gebrauch NighmatIQ

- Dämmerungsschalter, zur Wandmontage im Innen- und Außenbereich geeignet.
- Funktion Dämmerungseinstellung über Poti einstellbar.
- Als Einzelsensor verwendbar.

Bestimmungsgemäßer Gebrauch NighmatIQ Plus

- Dämmerungsschalter, zur Wandmontage im Innen- und Außenbereich geeignet.
- Funktionen über Steinel Connect App einstellbar.
- Als Einzelsensor oder mit Bluetooth vernetzt verwendbar.

Funktionsprinzip

- Der Dämmerungsschalter erfasst mit Hilfe des Lichtsensors die Umgebungshelligkeit und vergleicht diese mit dem eingestellten Helligkeitsschwellenwert.
- Liegt die Umgebungshelligkeit unter dem Helligkeitsschwellenwert, wird der angeschlossene Verbraucher eingeschaltet.
- Liegt die Umgebungshelligkeit über dem Helligkeitsschwellenwert, wird der angeschlossene Verbraucher ausgeschaltet.

Lieferumfang NightmatIQ / NightmatIQ Plus

3.1

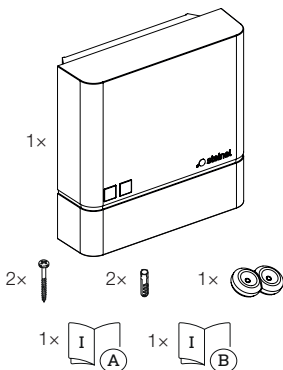

- 1 NightmatIQ / NightmatIQ Plus
- 2 Schrauben
- 2 Dübel
- 1 Dichtstopfen
- 1 Sicherheitsdatenblatt
- 1 Quick-Start

Produktmaße NightmatIQ / NightmatIQ Plus

3.2

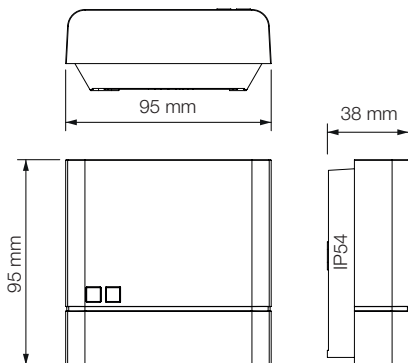

Geräteübersicht NightmatIQ

3.3

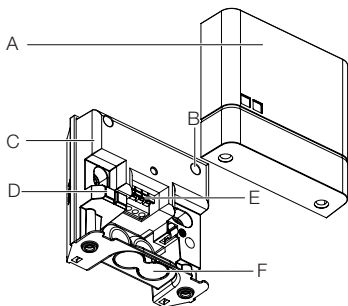

- A Abdeckung
- B Poti Dämmerungseinstellung
- C Gehäuse Dämmerungsschalter
- D Helligkeitssensor
- E Anschlussklemme
- F Optionale Öffnung für Aufputzverkabelung

3.4



- G Detail: Poti Dämmerungseinstellung

Geräteübersicht NightmatIQ Plus

3.5

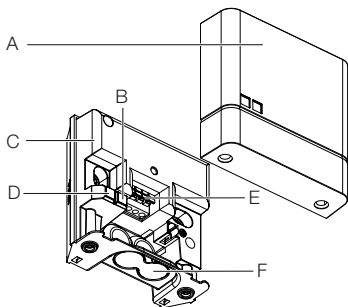

- A Abdeckung
- B Status-LED
- C Gehäuse Dämmerungsschalter
- D Helligkeitssensor
- E Anschlussklemme
- F Optionale Öffnung für Aufputzverkabelung

4. Elektrischer Anschluss

Schaltplan

4.1

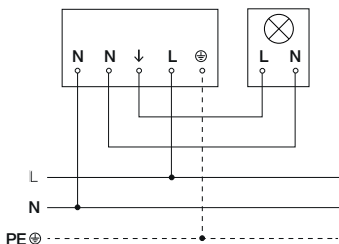

Die Netzzuleitung besteht aus einem 3-adrigen Kabel:

L = Phase (meistens schwarz, braun oder grau)

N = Neutraleiter (meistens blau)

PE = Schutzleiter (grün/gelb)

Das Gerät kann auch elektrisch nach einem Netzschalter angeschlossen werden, wenn sichergestellt ist, dass der Netzschalter ständig eingeschaltet ist.

Die Dichtstopfen sind für eine Netzzuleitung mit einem Außendurchmesser von 5 - 10 mm vorgesehen.

5. Montage



Gefahr durch elektrischen Strom!

Die Berührung von stromführenden Teilen kann zu elektrischem Schock, Verbrennungen oder Tod führen.

- Strom abschalten und Spannungszufuhr unterbrechen.
- Spannungsfreiheit mit Spannungsprüfer kontrollieren.
- Sicherstellen, dass die Spannungszufuhr unterbrochen bleibt.

Gefahr von Sachschäden!

Ein Vertauschen der Anschlussleitungen kann zu Kurzschluss führen.

- Anschlussleitungen identifizieren.
- Anschlussleitungen korrekt verbinden.

Montagevorbereitung

- Alle Bauteile auf Beschädigung prüfen. Bei Schäden das Gerät nicht in Betrieb nehmen.
- Geeigneten Montageort auswählen.
 - Erschütterungsfrei.
 - Nicht in explosionsgefährdeten Bereichen.
 - Nicht auf leicht entflammbaren Oberflächen.
 - Das Gerät darf nicht durch das Licht des angeschlossenen Verbrauchers beeinflusst werden.

Montageschritte

5.1

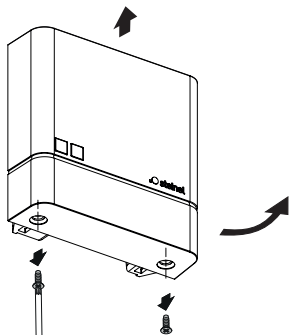

- Stromversorgung abschalten.
- Prüfen, dass die Spannungszufuhr abgeschaltet ist.
- Abdeckung abschrauben und abziehen.

5.2

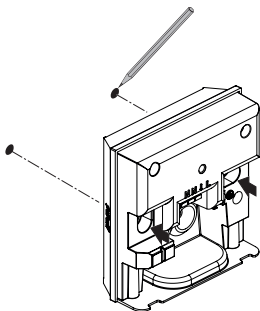

- Bohrlöcher anzeichnen.

5.3

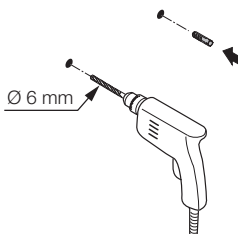

- Löcher bohren (\varnothing 6 mm) und Dübel einsetzen.

Unterputz-Variante

5.4

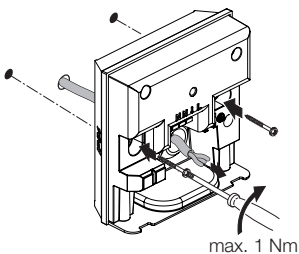

- Kabel durch das Gerät führen.
- Gerät mit einem Drehmoment von max. 1 Nm anschrauben.

Aufputz-Variante

5.5

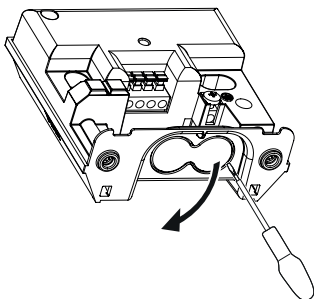

- Die optionale Öffnung für Aufputzverkabelung vorsichtig mit einem Schraubendreher herausbrechen.

5.6



- Dichtstopfen einsetzen.

5.7

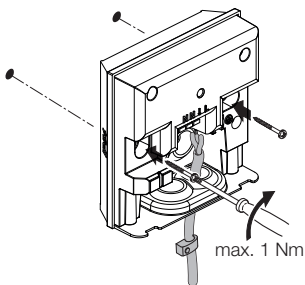

- Kabel durch das Gerät führen.
- Gerät mit einem Drehmoment von max. 1 Nm anschrauben.

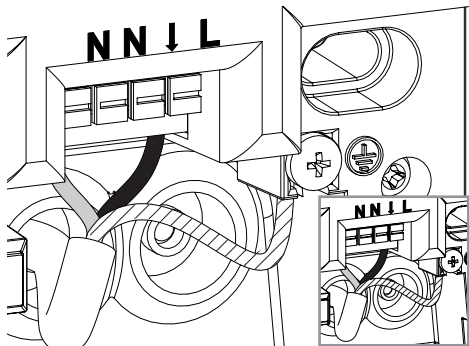

- Netzzuleitung laut Schaltplan anschließen.
→ „4. Elektrischer Anschluss“

5.9

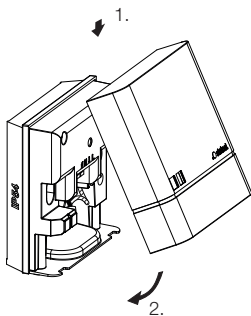

- Abdeckung aufsetzen.

5.10

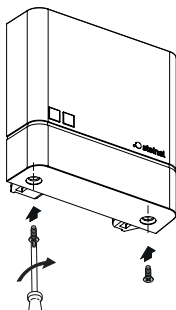

- Abdeckung anschrauben.



- Stromversorgung einschalten.
 - Funktionen einstellen.
- „6. Funktion“

6. Funktion

NightmatIQ

Bei der NightmatIQ wird die Dämmerungseinstellung manuell über den Poti Dämmerungseinstellung vorgenommen.



Gefahr durch elektrischen Strom!

Die Berührung von stromführenden Teilen kann zu elektrischem Schock, Verbrennungen oder Tod führen.

- Strom abschalten und Spannungszufuhr unterbrechen.
- Spannungsfreiheit mit Spannungsprüfer kontrollieren.
- Sicherstellen, dass die Spannungszufuhr unterbrochen bleibt.

- **Werkseinstellungen**

- Dämmerungseinstellung: 75 Lux

Dämmerungseinstellung (G)

Die Ansprechhelligkeit (Dämmerung) kann stufenlos von ca. 1-75 Lux eingestellt werden.

- ☀ = Dämmerungsbetrieb (ca. 75 Lux)
- ☾ = Dämmerungsbetrieb/Nachtbetrieb (ca. 1 Lux)

Manuelle Dämmerungseinstellung NightmatIQ

6.1

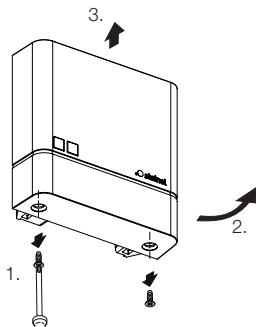

- Stromversorgung abschalten.
- Prüfen, dass die Spannungszufuhr abgeschaltet ist.
- Abdeckung abschrauben.

6.2

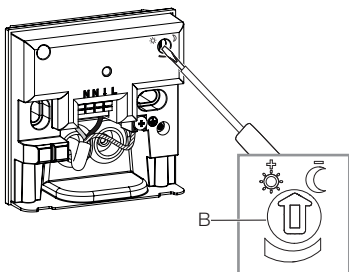

- Gewünschte Ansprechschwelle der Dämmerungseinstellung stufenlos mit dem Schraubendreher einstellen.

6.3

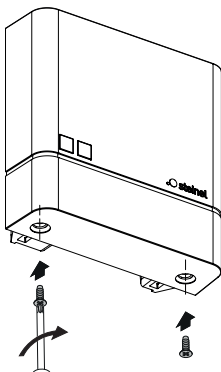

- Abdeckung anschrauben.

6.4



- Stromversorgung einschalten.

NightmatIQ Plus

Bei der NightmatIQ Plus erfolgt die Einstellung der Funktionen über die Steinel Connect App.

Steinel Connect App

Für die Konfiguration des Geräts mit Smartphone oder Tablet muss die STEINEL Connect App aus Ihrem AppStore heruntergeladen werden. Es ist ein Bluetooth-fähiges Smartphone oder Tablet erforderlich.



Android



iOS



Funktionen, die durch die Steinel Connect App einstellbar sind:

- Dämmerungseinstellung.

Hinweis:

Es muss ein Mindestabstand von 3 m zum WLAN-Router und zu den Access Points eingehalten werden, um Fehlfunktionen auszuschließen.

LED-Funktion

Initialisierung: LED leuchtet dauerhaft.

Normalbetrieb: LED aus.

Identifizierung: LED blinkt langsam.

Firmware Update: LED blinkt schnell.

Fehler: LED blinkt schnell.

Werkseinstellungen

- Dämmerungseinstellung: 1.000 Lux

Dämmerungseinstellung

Die Ansprechhelligkeit (Dämmerung) kann stufenlos von ca. 1-1.000 Lux eingestellt werden.

- ☀ = Dämmerungsbetrieb (ca. 1.000 Lux)
- ☾ = Dämmerungsbetrieb/Nachtbetrieb (ca. 1 Lux)

Bluetooth Vernetzung (Bluetooth Mesh)

Der Sensor-Schalter entspricht dem Bluetooth Mesh Standard. Er kann mit allen Produkten die dem Bluetooth Mesh Standard entsprechen vernetzt werden.

Die Konfiguration des Sensor-Schalters erfolgt per Steinel Connect App. Bei der ersten Verbindung zwischen Sensor-Schalter und Steinel Connect App werden auf dem Smartphone oder Tablet entsprechende Netzwerkschlüssel gespeichert. Durch die Schlüssel ist ein unbefugter Zugriff auf den Sensor ausgeschlossen.

Für den Zugriff über ein weiteres Smartphone oder Tablet muss der Netzwerkschlüssel geteilt werden.

Schaltzeiten

Neben der Einstellung zum Dämmerungswert können über die App auch Schaltzeiten eingestellt werden bei denen angeschlossene Verbraucher EIN bzw. AUS geschaltet werden.

Die NightmatIQ plus erhält durch die Bluetooth-Verbindung mit einem Smartphone/Tablet die aktuelle Uhrzeit und nutzt diese für die zukünftige Schalthandlung.

Wird die Spannungsversorgung der NightmatIQ plus unterbrochen, verliert sie die gespeicherte Uhrzeit. Auf Basis des Sonnenverlaufs der vorherigen Tage ermittelt die NightmatIQ plus eine ungefähre Uhrzeit. Um die exakte Uhrzeit wiederherzustellen ist eine erneute Verbindung mit der App erforderlich.

7. Reinigung und Pflege

Das Gerät ist wartungsfrei.



Gefahr durch elektrischen Strom!

Der Kontakt von Wasser mit stromführenden Teilen kann zu elektrischem Schock, Verbrennungen oder Tod führen.

- Gerät nur im trockenen Zustand reinigen.

Gefahr von Sachschäden!

Durch falsche Reinigungsmittel kann das Gerät beschädigt werden.

- Gerät mit einem leicht angefeuchteten Tuch ohne Reinigungsmittel reinigen.

8. Entsorgung

Elektrogeräte, Batterien, Zubehör und Verpackungen müssen einer umweltgerechten Wiederverwertung zugeführt werden.



Werfen Sie Elektrogeräte und Batterien nicht in den Hausmüll!

Nur für EU-Länder:

Gemäß der geltenden Europäischen Richtlinie über Elektro- und Elektronik-Altgeräte und ihrer Umsetzung in nationales Recht müssen nicht mehr gebrauchsfähige Elektrogeräte und Batterien getrennt gesammelt und einer umweltgerechten Wiederverwertung zugeführt werden.

9. Herstellergarantie

Herstellergarantie der STEINEL Vertrieb GmbH,
Dieselstraße 80-84, 33442 Herzebrock-Clarholz

Alle STEINEL-Produkte erfüllen höchste Qualitätsansprüche. Aus diesem Grund leisten wir als Hersteller Ihnen als Endkunden gerne eine Garantie gemäß den nachstehenden Bedingungen:

Wir leisten Garantie durch kostenlose Behebung der Mängel (Reparatur oder Austausch ggf. durch ein gleich- oder höherwertiges Nachfolgemodell) oder – nach Ihrer Wahl – Erstellung einer Gutschrift, die nachweislich innerhalb der Garantiezeit auf einem Material- oder Herstellungsfehler beruhen. Die Garantie gilt für sämtliche STEINEL-Produkte, die in Deutschland gekauft und verwendet werden, ausschließlich der STEINEL-Professional-Produkte. Die Garantiezeit für Ihr erworbenes STEINEL-Produkt beträgt 3 Jahre (bei Produkten der XLED home-Serie 5 Jahre) und beginnt mit dem Kaufdatum Ihres Produktes. Diese Herstellergarantie lässt gesetzliche Gewährleistungsansprüche, die Ihnen als Verbraucher gegenüber dem Verkäufer nach geltendem Recht einschließlich besonderer Schutzbestimmungen für Verbraucher zustehen können, unberührt. Die hier beschriebenen Leistungen gelten zusätzlich zu den gesetzlichen Gewährleistungsansprüchen und beschränken oder ersetzen diese nicht. Die Inanspruchnahme Ihrer gesetzlichen Rechte bei Mängeln ist unentgeltlich.

Ausdrücklich ausgenommen von dieser Garantie sind alle auswechselbaren Leuchtmittel.

Darüber hinaus ist die Garantie ausgeschlossen:

- bei einem gebrauchsbedingten oder sonstigen natürlichen Verschleiß von Produktteilen oder Mängeln am STEINEL-Produkt, die auf gebrauchsbedingtem oder sonstigem natürlichen Verschleiß zurückzuführen sind,

- bei nicht bestimmungs- oder unsachgemäßem Gebrauch des Produkts oder Missachtung der Bedienungshinweise,
- wenn An- und Umbauten bzw. sonstige Modifikationen an dem Produkt eigenmächtig vorgenommen,
- wurden oder Mängel auf die Verwendung von Zubehör-, Ergänzungs- oder Ersatzteilen zurückzuführen sind, die keine STEINEL-Originalteile sind,
- wenn Wartung und Pflege der Produkte nicht entsprechend der Bedienungsanleitung erfolgt sind,
- wenn Anbau- und Installation nicht gemäß den Installationsvorschriften von STEINEL ausgeführt wurden,
- bei Transportschäden oder -verlusten.

Es gilt deutsches Recht unter Ausschluss des Übereinkommens der Vereinten Nationen über Verträge über den internationalen Warenkauf (CISG).

Geltendmachung

Wenn Sie die Garantie in Anspruch nehmen wollen, senden Sie es bitte vollständig mit dem Original-Kaufbeleg, der die Angabe des Kaufdatums und der Produktbezeichnung enthalten muss, an Ihren Händler oder direkt an uns, die STEINEL Vertrieb GmbH - Reklamationsabteilung-, Dieselstraße 80-84, 33442 Herzebrock-Clarholz. Wir empfehlen Ihnen daher, Ihren Kaufbeleg bis zum Ablauf der Garantiezeit sorgfältig aufzubewahren. Wir tragen die Transportkosten, jedoch nicht die Transportrisiken der Rücksendung.

3 JAHRE
HERSTELLER
GARANTIE

10. Technische Daten

- Abmessungen (H x B x T): 95 x 95 x 38 mm
- Netzanschluss: 220 – 240 V, 50/60 Hz
- Leistungsaufnahme: *NightmatIQ* < 0,7 W
NightmatIQ plus < 0,5 W
- Dämmerungseinstellung: *NightmatIQ*: 1 - 75 Lux
NightmatIQ plus: 1 - 1.000 Lux
- Sensorik: Phototransistor
- Temperaturbereich: -20 bis +40 °C
- Frequenz Bluetooth (nur *NightmatIQ plus*): 2,4 - 2,48 GHz
- Sendeleistung Bluetooth (nur *NightmatIQ plus*): 4 dBm/2,5 mW
- Schutzart: IP 54

Schaltleistung

- Glüh- /Halogenlampenlast: 1.000 W
- Niedervolt Halogenlampen: 1.000 VA
- Leuchtstofflampen unkompensiert: 500 VA
- Leuchtstofflampen reihenkompensiert: 500 VA
- Leuchtstofflampen parallelkompensiert: 500 VA
- Leuchtstofflampen EVG: 250 W
- LED Lampen <2W: 100 W
- LED Lampen >2W <8W: 125 W
- LED Lampen >8W: 250 W
- Kapazitive Belastung: 88 µF

11. Störungsbehebung

Gerät ohne Spannung.

- Sicherung nicht eingeschaltet oder defekt.
 - Sicherung einschalten.
 - Defekte Sicherung austauschen.
- Leitung unterbrochen.
 - Leitung mit Spannungsprüfer überprüfen.
- Kurzschluss in der Netzzuleitung.
 - Anschlüsse überprüfen.
- Eventuell vorhandener Netzschalter aus.
 - Netzschalter einschalten.

Gerät schaltet nicht ein.

- Dämmerungseinstellung falsch gewählt.
 - Dämmerungseinstellung neu einstellen.
- Netzschalter AUS.
 - Netzschalter einstellen.
- Sicherung nicht eingeschaltet oder defekt.
 - Sicherung einschalten.
 - Defekte Sicherung austauschen.

Index

1.	About this document	3
2.	General safety precautions	3
3.	System description	4
4.	Electrical connection	9
5.	Installation	10
6.	Function	19
7.	Cleaning and maintenance	24
8.	Disposal	24
9.	Manufacturer's warranty	25
10.	Technical specifications	26
11.	Troubleshooting	27

1. About this document

- Under copyright. Reproduction either in whole or in part only with our consent.
- Subject to change in the interest of technical progress.



Hazard warning!



Warning of hazards from electricity!



Warning of hazards from water!

2. General safety precautions



Failure to observe these operating instructions presents hazards!

These instructions contain important information on the safe use of this product. Particular attention is drawn to potential hazards. Failure to observe this information may lead to death or serious injuries.

- Read instructions carefully.
- Follow safety advice.
- Keep instructions within easy reach.
- Working with electrical current may produce hazardous situations. Touching live parts can result in electrical shock, burns or death.
- Work on mains voltage must only be performed by qualified, skilled personnel.
- National wiring regulations and electrical operating conditions must be observed (e.g. DE: VDE 0100, AT: ÖVE-ÖNORM E8001-1, CH: SEV 1000).
- Only use genuine replacement parts.
- Repairs must only be carried out by companies qualified to do so.

3. System description

Proper use - NighmatIQ

- Photo-cell controller, suitable for wall mounting indoors and outdoors.
- Twilight setting function can be selected by potentiometer
- Can be used as a standalone sensor.

Proper use - NighmatIQ Plus

- Photo-cell controller, suitable for wall mounting indoors and outdoors.
- Functions can be set via the Steinel Connect app.
- Can be used as a standalone sensor or interconnected with Bluetooth.

Operating principle

- The photo-cell controller detects ambient light level by means of the light sensor and compares this with the light-level threshold selected.
- If ambient brightness is below the light-level threshold, the connected load is switched ON.
- If ambient brightness is above the light-level threshold, the connected load is switched OFF.

Package contents - NightmatIQ / NightmatIQ Plus

3.1

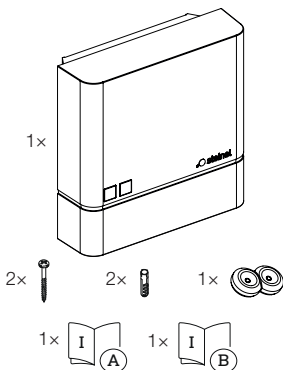

- 1 NightmatIQ / NightmatIQ Plus
- 2 screws
- 2 wall plugs
- 1 sealing plug
- 1 safety data sheet
- 1 quick-start guide

Product dimensions - NightmatIQ / NightmatIQ Plus

3.2

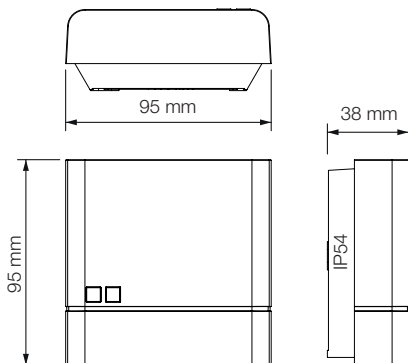

NightmatIQ product components

3.3

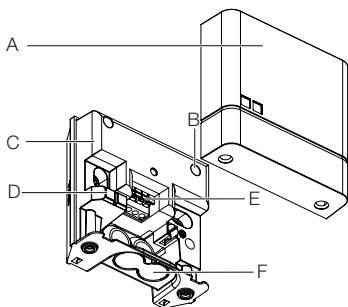

- A Cover
- B Twilight setting potentiometer
- C Photo-cell controller housing
- D Light-level sensor
- E Connecting terminal
- F Optional inlet for surface wiring

3.4



- G Detail: twilight setting potentiometer

NightmatIQ Plus product components

3.5

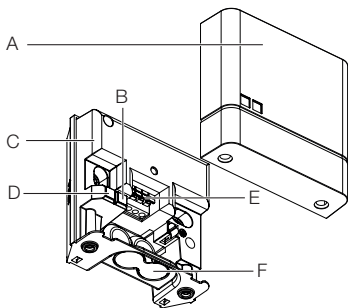

- A Cover
- B Status LED
- C Photo-cell controller housing
- D Light-level sensor
- E Connecting terminal
- F Optional inlet for surface wiring

4. Electrical connection

Circuit diagram

4.1

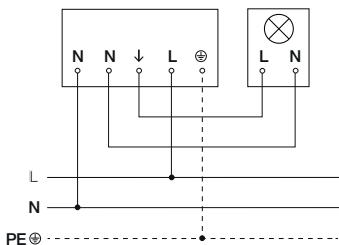

The mains power supply lead is a 3-core cable:

- L** = Phase conductor (usually black, brown or grey)
- N** = Neutral conductor (usually blue)
- PE** = protective-earth conductor (green/yellow)

The floodlight can also be connected to the power supply downstream of a mains switch if it is ensured that the mains switch is left ON all the time.

The sealing plugs provided are intended for a mains supply lead with an outer diameter of 5-10 mm.

5. Installation



Hazard from electrical power.

Touching live parts can result in electrical shock, burns or death.

- Switch OFF power and interrupt power supply.
- Using a voltage tester, check to make sure that the power supply is disconnected.
- Make sure power supply remains interrupted.

Risk of damage to property!

Mixing up connection leads may produce a short circuit.

- Identify connection leads.
- Connect the leads correctly.

Preparing for installation

- Check all components for damage. Do not use the floodlight if it is damaged.
- Select an appropriate site to install the product.
 - Vibration-free.
 - Not in explosive atmospheres.
 - Not on normally flammable surfaces.
 - The unit must not be influenced by light from the connected load.

Mounting procedure

5.1

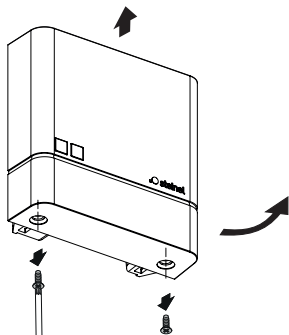

- Switch OFF power supply.
- Check to make sure the power supply is switched OFF.
- Unscrew and detach cover.

5.2

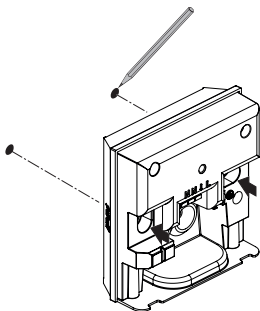

- Mark drill holes.

5.3

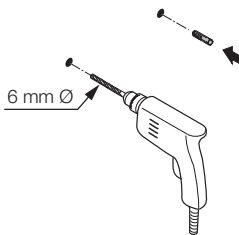

- Drill holes (\varnothing 6 mm) and fit wall plugs.

Concealed version

5.4

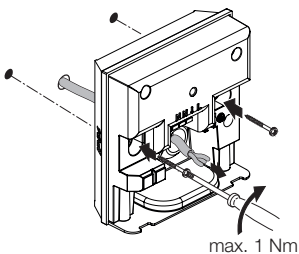

- Route cable through the unit.
- Fit unit, tightening screws with a torque of no more than 1 Nm.

Surface-mounted installation

5.5

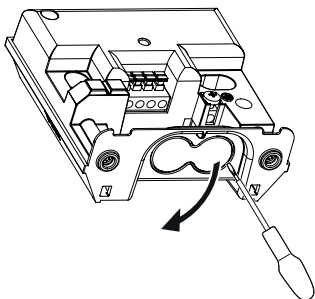

- Using a screwdriver, carefully prise out the optional inlet for surface wiring.

5.6

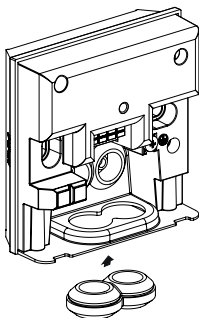

- Fit sealing plug.

5.7

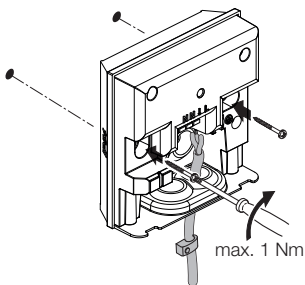

- Route cable through the unit.
- Fit unit, tightening screws with a torque of no more than 1 Nm.

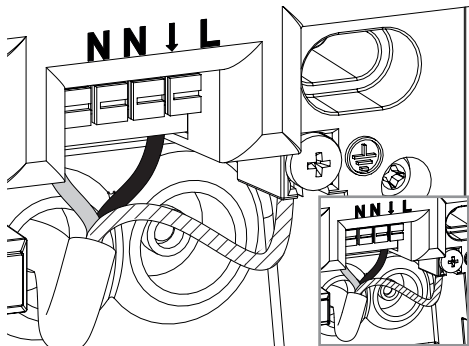

- Connect mains power supply lead as shown in the wiring diagram.

→ „4. Electrical connection“

5.9

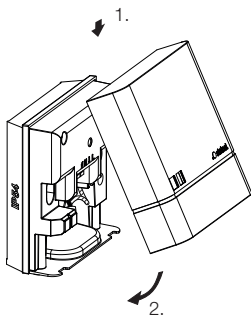

- Fit cover.

5.10

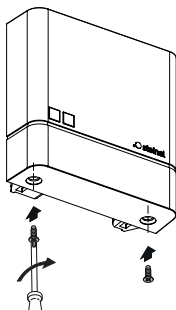

- Screw on cover.



- Switch ON power supply.
 - Setting functions.
- „6. Function“

6. Function

NightmatIQ

On the NightmatIQ, the twilight setting is selected by hand at the twilight setting potentiometer.



Hazard from electrical power.

Touching live parts can result in electrical shock, burns or death.

- Switch OFF power and interrupt power supply.
- Using a voltage tester, check to make sure that the power supply is disconnected.
- Make sure power supply remains interrupted.

- **Factory settings**

- Twilight level: 75 lux

Twilight setting (G)

The response threshold (twilight) can be infinitely varied from approx. 1 to 75 lux.

- ☀ = Twilight operating mode (approx. 75 lux)
- ☾ = twilight operating mode/night-time operating mode (approx. 1 lux)

Manual twilight setting for NightmatIQ

6.1

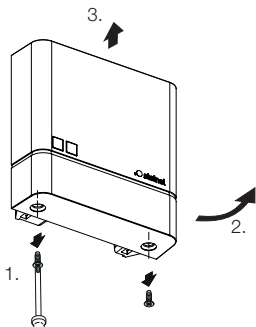

- Switch OFF power supply.
- Check to make sure the power supply is switched OFF.
- Unscrew cover.

6.2

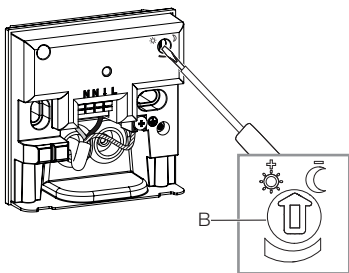

- Using the screwdriver, set the response twilight threshold to any chosen level.

6.3

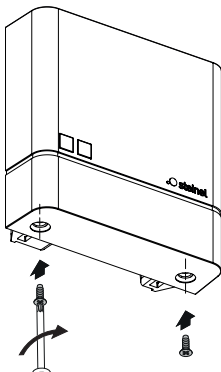

- Screw on cover.

6.4



- Switch ON power supply.

NightmatIQ Plus

NightmatIQ Plus functions are set via the Steinel Connect app.

Steinel Connect app

To configure the unit via smartphone or tablet, you must download the STEINEL Connect app from your app store. You will need a Bluetooth-capable smartphone or tablet.



Android



iOS



Functions that can be set via the Steinel Connect app:

- Twilight setting.

Note:

To rule out malfunctioning, a minimum distance of 3 m must be allowed from the Wi-Fi router and the access points.

LED function

Initialisation: LED permanently lights up.

Normal mode: LED OFF.

Identification: LED slowly flashes.

Firmware update: LED rapidly flashes.

Error: LED rapidly flashes.

Factory settings

- Twilight level: 1,000 lux

Twilight setting

The response threshold (twilight) can be infinitely varied from approx. 1 to 1,000 lux.

- ☀ = twilight operating mode (approx. 1,000 lux)
- ☾ = twilight operating mode/night-time operating mode (approx. 1 lux)

Bluetooth interconnection (Bluetooth mesh)

The sensor switch complies with the Bluetooth mesh standard. It can be interconnected with all products complying with the Bluetooth mesh standard.

The sensor switch is configured by Steinel Connect app. Appropriate network keys are saved on the smartphone or tablet the first time a connection is made between sensor switch and Steinel Connect app. The key rules out any unauthorised access to the sensor.

The network key must be shared for access via another smartphone or tablet.

Switching times

Besides setting the twilight level, the app can also be used for selecting times at which connected loads are switched ON or OFF.

The NightmatIQ plus receives the current time of day via the Bluetooth connection with a smartphone/tablet, and uses this for future switching operations.

Any interruption in the power supply to the NightmatIQ plus will result in the memorised time of day being lost.

The NightmatIQ plus determines an approximate time of day on the basis of the sun's angle of incidence from the past few days. To restore the exact time of day, you must reconnect to the app.

7. Cleaning and maintenance

The tool requires no maintenance.



Hazard from electrical power.

Contact between water and live parts can result in electrical shock, burns or death.

- Only clean tool in a dry state.

Risk of damage to property!

Using the wrong cleaning product can damage the light.

- Clean tool with a moist cloth without detergent.

8. Disposal

Electrical and electronic equipment, batteries, accessories and packaging must be recycled in an environmentally compatible manner.



Do not dispose of batteries or electrical and electronic equipment as domestic waste.

EU countries only:

Under the current European Directive on Waste Electrical and Electronic Equipment and its implementation in national law, batteries and electrical and electronic equipment no longer suitable for use must be collected separately and recycled in an environmentally compatible manner.

9. Manufacturer's warranty

This Steinel product has been manufactured with utmost care, tested for proper operation and safety and then subjected to random sample inspection. Steinel guarantees that it is in perfect condition and proper working order. The warranty period is 36 months and starts on the date of sale to the consumer. We will remedy defects caused by material flaws or manufacturing faults. The warranty will be met by repair or replacement of defective parts at our own discretion. The warranty shall not cover damage to wear parts, damage or defects caused by improper treatment or maintenance. Further consequential damage to other objects shall be excluded.

Claims under the warranty will only be accepted if the unit is sent fully assembled and well-packed with a brief description of the fault, a receipt or invoice (date of purchase and dealer's stamp) to the appropriate Service Centre.

Repair service:

If defects occur outside the warranty period or are not covered by the warranty, ask your nearest service station for the possibility of repair.

3 YEAR
MANUFACTURER'S
WARRANTY

10. Technical specifications

- Dimensions (H × W × D): 95 × 95 × 38 mm
- Power supply: 220-240 V, 50/60 Hz
- Power consumption: *NightmatIQ* < 0.7 W
NightmatIQ plus < 0.5 W
- Twilight setting: *NightmatIQ*: 1-75 Lux
NightmatIQ plus: 1-1,000 lux
- Sensor system: phototransistor
- Temperature range: -20 to +40 °C
- Bluetooth frequency (*NightmatIQ plus* only): 2.4-2.48 GHz
- Bluetooth transmission power (*NightmatIQ plus* only): 4 dBm/2.5 mW
- IP rating: IP54

Switching capacity

- Incandescent / halogen lamp load: 1,000 W
- Low-voltage halogen lamps: 1,000 VA
- Fluorescent lamps, uncorrected: 500 VA
- Fluorescent lamps, series-corrected: 500 VA
- Fluorescent lamps, parallel-corrected: 500 VA
- Fluorescent lamps, electronic ballast: 250 W
- LED lamps <2W: 100 W
- LED lamps >2W <8W: 125 W
- LED lamps >8W: 250 W
- Capacitive load: 88 μF

11. Troubleshooting

Unit without power.

- Fuse not switched ON or faulty.
 - Switch ON fuse.
 - Change faulty fuse.
- Break in wiring.
 - Check wiring with voltage tester.
- Short circuit in mains power supply lead.
 - Check connections.
- Any mains switch OFF
 - Switch ON mains switch.

Unit does not switch ON.

- Wrong twilight setting selected.
 - Reset twilight setting.
- Mains switch OFF.
 - Turn on mains switch.
- Fuse not switched ON or faulty.
 - Switch ON fuse.
 - Change faulty fuse.
- Rapid movements being suppressed to minimise malfunctioning, or detection zone too small or incorrectly defined.
 - Check and adjust detection zone.
- Light source faulty.

Sommaire

1.	À propos de ce document	3
2.	Consignes de sécurité générales	3
3.	Description de l'appareil	4
4.	Branchement électrique	9
5.	Montage	10
6.	Fonctions	19
7.	Nettoyage et entretien	24
8.	Recyclage	24
9.	Garantie du fabricant	25
10.	Caractéristiques techniques	26
11.	Élimination des défauts	27

1. À propos de ce document

- Il est protégé par la loi sur les droits d'auteur. Une réimpression, même partielle, n'est autorisée qu'après notre accord préalable.
- Sous réserve de modifications techniques permettant des améliorations techniques.



Attention danger !



Attention danger dû au courant électrique !



Attention danger dû à l'eau !

2. Consignes de sécurité générales



Danger en cas de non-respect des instructions du mode d'emploi !

Le présent document contient des informations importantes sur la manipulation et l'utilisation en toute sécurité de l'appareil. Nous signalerons les risques éventuels au fur et à mesure dans ce document. L'ignorance des risques peut entraîner de graves blessures, voire la mort.

- Veuillez lire attentivement le mode d'emploi.
- Veuillez respecter les consignes de sécurité.
- Le conserver à portée de la main.
- Le travail sur des installations électriques peut présenter des dangers. Le contact avec des pièces sous tension peut entraîner une électrocution, des brûlures, voire la mort.
- Seules des personnes qualifiées et spécialisées sont autorisées à effectuer des travaux sur le réseau électrique.
- Ces travaux doivent donc être effectués correctement et conformément aux normes en vigueur (p. ex. NF C-15100, A - ÖVE / ÖNORM E8001-1, CH - SEV 1000).

- Utiliser uniquement des pièces de rechange d'origine.
- Uniquement des entreprises spécialisées sont autorisées à effectuer des réparations.

3. Description de l'appareil

Utilisation conforme aux prescriptions du NighmatIQ

- Interrupteur crépusculaire convenant au montage mural à l'intérieur et à l'extérieur.
- Réglage du seuil de déclenchement via le potentiomètre.
- Il peut être utilisé sous forme de détecteur isolé.

Utilisation conforme aux prescriptions du NighmatIQ Plus

- Interrupteur crépusculaire convenant au montage mural à l'intérieur et à l'extérieur.
- Les fonctions peuvent être réglées depuis l'application STEINEL Connect.
- Il peut être utilisé sous forme de détecteur isolé ou mis en réseau via Bluetooth.

Principe de fonctionnement

- L'interrupteur crépusculaire détecte la luminosité ambiante au moyen de son capteur de lumière et la compare avec le seuil de déclenchement réglé.
- Lorsque la luminosité ambiante est inférieure au seuil de déclenchement, le consommateur connecté s'allume.
- Lorsque la luminosité ambiante est supérieure au seuil de déclenchement, le consommateur connecté s'éteint.

Contenu de la livraison du NightmatIQ / NightmatIQ Plus

3.1

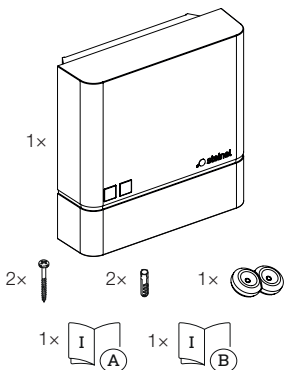

- 1 NightmatIQ / NightmatIQ Plus
- 2 vis
- 2 chevilles
- 1 bouchon
- 1 fiche technique de sécurité
- 1 démarrage rapide

Dimensions du NightmatIQ / NightmatIQ Plus

3.2

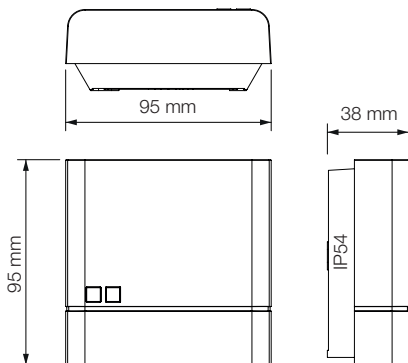

Vue d'ensemble du NightmatIQ

3.3

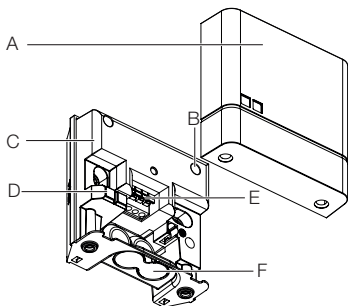

- A Cache
- B Potentiomètre pour régler le seuil de déclenchement
- C Boîtier de l'interrupteur crépusculaire
- D Détecteur de luminosité
- E Domino
- F Ouverture également possible pour le câblage en saillie

3.4



- G Détail : potentiomètre pour régler le seuil de déclenchement

Vue d'ensemble du NightmatIQ Plus

3.5

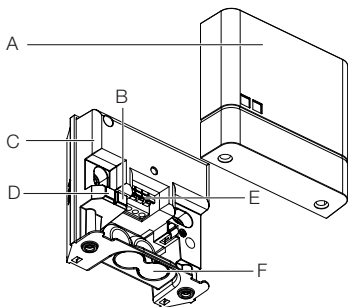

- A Cache
- B LED d'état
- C Boîtier de l'interrupteur crépusculaire
- D Détecteur de luminosité
- E Domino
- F Ouverture également possible pour le câblage en saillie

4. Branchement électrique

Schéma des connexions

4.1

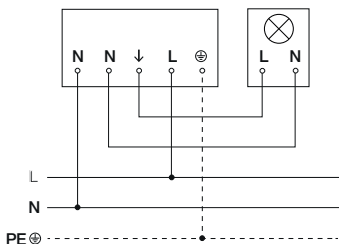

Le câble secteur est composé d'un câble à 3 conducteurs :

L = phase (généralement noir, marron ou gris)

N = neutre (généralement bleu)

PE = conducteur de terre (vert/jaune)

Il est possible de brancher l'appareil également en aval d'un interrupteur secteur s'il est garanti que ce dernier est toujours en position MARCHE.

Les bouchons sont prévus pour un câble secteur ayant un diamètre extérieur de 5 à 10 mm.

5. Montage



Risque d'électrocution !

Le contact avec des pièces sous tension peut entraîner une électrocution, des brûlures, voire la mort.

- Mettre l'appareil hors tension et couper l'alimentation électrique.
- Vérifier l'absence de tension à l'aide d'un testeur de tension.
- S'assurer que l'alimentation électrique demeure coupée.

Risque de dommages matériels !

Une interversion des câbles de raccordement peut conduire à un court-circuit.

- Repérer les câbles de raccordement.
- Brancher correctement les câbles de raccordement.

Préparatifs de montage

- Contrôler l'absence de dommages sur toutes les pièces. Ne pas mettre l'appareil en service en cas de dommage.
- Sélectionner le lieu d'installation approprié.
 - À l'abri d'éventuelles secousses.
 - Il est interdit d'installer l'appareil dans des zones à risque d'explosion.
 - Ne pas monter l'appareil sur des surfaces inflammables.
 - La lumière du consommateur raccordé ne doit pas affecter le fonctionnement de l'appareil.

Étapes de montage

5.1

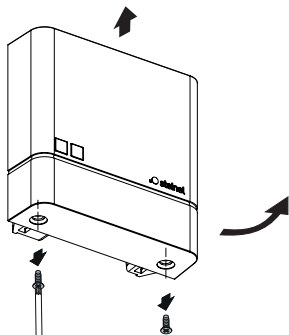

- Couper l'alimentation électrique.
- Vérifier que l'alimentation électrique a été coupée.
- Dévisser le cache et l'enlever.

5.2

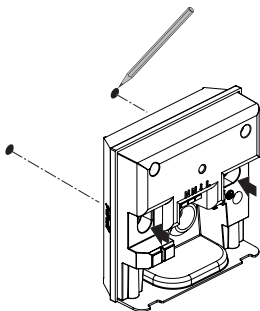

- Marquer l'emplacement des trous.

5.3

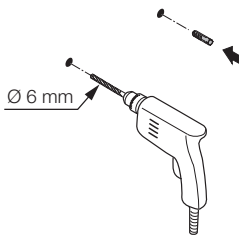

- Percer les trous (\varnothing 6 mm) puis mettre les chevilles.

Variante encastrée

5.4

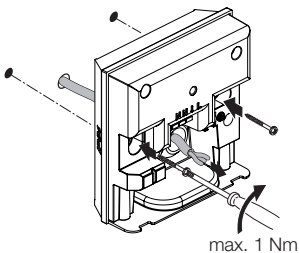

- Faire passer le câble à travers l'appareil.
- Visser l'appareil à un couple maximum de 1 Nm.

Version en saillie

5.5

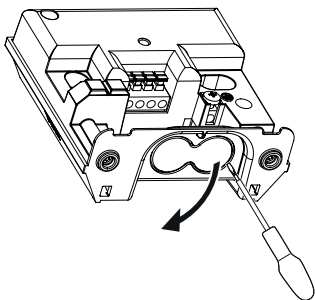

- Ôter avec précaution l'ouverture optionnelle pour le câblage en saillie à l'aide d'un tournevis.

5.6



- Mettre le bouchon.

5.7

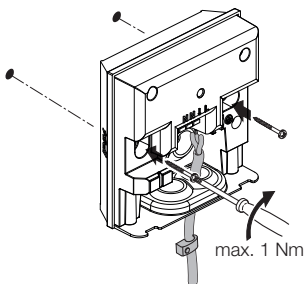

- Faire passer le câble à travers l'appareil.
- Visser l'appareil à un couple maximum de 1 Nm.

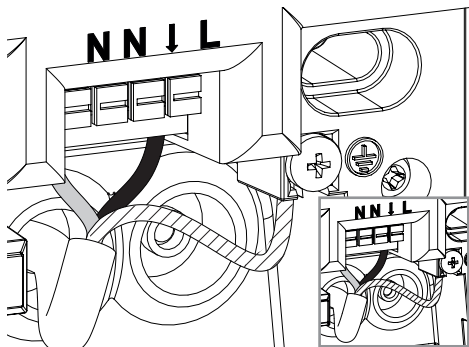

- Brancher le câble secteur conformément au schéma des connexions.

→ „4. Branchement électrique“

5.9

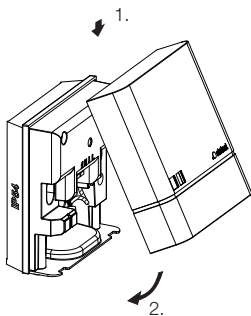

- Poser le cache.

5.10

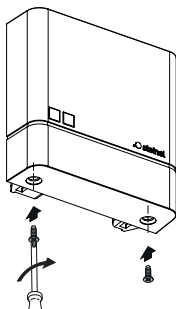

- Visser le cache.



- Mettre l'appareil sous tension.
 - Régler les fonctions.
- „6. Fonctions“

6. Fonctions

NightmatIQ

Sur le modèle NightmatIQ, le réglage du seuil de déclenchement a lieu manuellement au moyen du potentiomètre Réglage du seuil de déclenchement.



Risque d'électrocution !

Le contact avec des pièces sous tension peut entraîner une électrocution, des brûlures, voire la mort.

- Mettre l'appareil hors tension et couper l'alimentation électrique.
- Vérifier l'absence de tension à l'aide d'un testeur de tension.
- S'assurer que l'alimentation électrique demeure coupée.
- **Réglages effectués en usine**
 - Réglage du seuil de déclenchement : 75 lx

Réglage du seuil de déclenchement (G)

Il est possible de régler progressivement la luminosité de déclenchement (crépuscule) entre env. 1 et 75 lx.

- ☼ = fonctionnement crépusculaire (env. 75 lx)
- ☾ = fonctionnement crépusculaire/fonctionnement nocturne (env. 1 lx)

Réglage manuel du seuil de déclenchement NightmatIQ

6.1

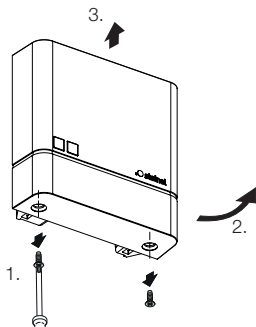

- Couper l'alimentation électrique.
- Vérifier que l'alimentation électrique a été coupée.
- Dévisser le couvercle.

6.2

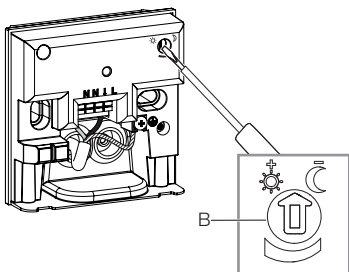

- Régler progressivement le seuil de réaction souhaité du réglage du seuil de déclenchement en utilisant un tournevis.

6.3

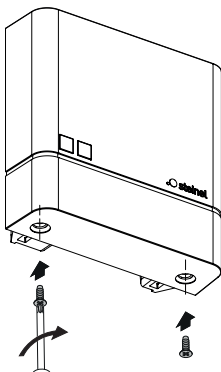

- Visser le cache.

6.4



- Mettre l'appareil sous tension.

NightmatIQ Plus

Sur le modèle NightmatIQ Plus, les fonctions sont réglées via l'appli STEINEL Connect.

L'appli STEINEL Connect

Il faut télécharger l'application STEINEL Connect depuis votre AppStore pour pouvoir configurer l'applique avec un smartphone ou une tablette. Un smartphone ou une tablette compatible Bluetooth est nécessaire.



Android



iOS



Les fonctions suivantes peuvent être réglées depuis l'appli STEINEL Connect :

- Réglage du seuil de déclenchement.

Remarque :

Il est nécessaire de respecter une distance minimale de 3 m entre l'appareil et le routeur WiFi et les points d'accès afin d'exclure tout dysfonctionnement.

Fonctions de la LED

Initialisation : la LED est allumée en permanence.

Fonctionnement normal : la LED est éteinte.

Identification : la LED clignote lentement.

Mise à jour du micrologiciel (Firmware) : la LED clignote rapidement

Réglages effectués en usine

- Réglage du seuil de déclenchement : 1 000 lx

Réglage du seuil de déclenchement

Il est possible de régler progressivement la luminosité de déclenchement (crépuscule) entre env. 1 et 1000 lx.

- ☀️ = fonctionnement crépusculaire (env. 1000 lx)
- 🌙 = fonctionnement crépusculaire/fonctionnement nocturne (env. 1 lx)

Mise en réseau via Bluetooth (technologie Bluetooth mesh)

Le détecteur type interrupteur encastré fonctionne avec la technologie Bluetooth mesh. Il peut être mis en réseau avec tous les produits fonctionnant avec la technologie Bluetooth mesh.

Le détecteur type interrupteur encastré est configuré depuis l'application STEINEL Connect. Lors de la première connexion du détecteur type interrupteur encastré avec l'application STEINEL Connect, des clés réseau correspondantes sont mémorisées sur le smartphone ou la tablette. Les clés empêchent tout accès non autorisé au détecteur.

Pour accéder au détecteur depuis un autre smartphone ou une autre tablette, il faut partager la clé réseau.

Heures de commutation

En plus de pouvoir régler le seuil de déclenchement, il est possible de régler depuis l'appli également des heures de commutation qui permettent d'ALLUMER et d'ÉTEINDRE les consommateurs raccordés.

Le modèle NightmatIQ plus reçoit l'heure actuelle grâce à la connexion Bluetooth avec un smartphone/une tablette et l'utilise pour les commutations ultérieures.

Lorsque l'alimentation en tension du NightmatIQ est interrompue, l'appareil perd l'heure enregistrée. En se basant sur la trajectoire du soleil pendant la journée précédente, NightmatIQ calcule l'heure approximative. Une nouvelle connexion avec l'appli est nécessaire pour rétablir l'heure exacte.

7. Nettoyage et entretien

L'appareil ne nécessite aucun entretien.



Risque d'électrocution !

Si des pièces sous tension sont au contact avec de l'eau, il y a risque d'électrocution, de brûlures, voire danger de mort.

- Nettoyer l'appareil uniquement à sec.

Risque de dommages matériels !

Des détergents inappropriés risquent d'endommager l'appareil.

- Nettoyer l'appareil avec un chiffon légèrement humide sans détergent.

8. Recyclage

Les appareils électriques, les batteries, les accessoires et les emballages doivent être soumis à un recyclage respectueux de l'environnement.



Ne pas jeter les appareils électriques et les batteries avec les ordures ménagères !

Uniquement pour les pays de l'UE :

Conformément à la directive européenne en vigueur relative aux appareils électriques et électroniques usagés et à son application dans le droit national, les appareils électriques et les batteries qui ne fonctionnent plus doivent être collectés séparément des ordures ménagères et doivent faire l'objet d'un recyclage écologique.

9. Garantie du fabricant

Ce produit STEINEL a été fabriqué avec le plus grand soin. Son fonctionnement et sa sécurité ont été contrôlés suivant des procédures fiables et il a été soumis à un contrôle final par sondage. STEINEL garantit un état et un fonctionnement irréprochables. La durée de garantie est de 36 mois et débute au jour de la vente au consommateur. Nous remédions aux défauts provenant d'un vice de matière ou de construction. La garantie sera assurée à notre discrétion par réparation ou échange des pièces défectueuses. La garantie ne s'applique ni aux pièces d'usure, ni aux dommages et défauts dus à une utilisation ou à une maintenance incorrecte. Les dommages consécutifs causés à d'autres objets sont exclus de la garantie. La garantie ne s'applique que si l'appareil non démonté est retourné au point de service après-vente le plus proche, dans un emballage adéquat, accompagné d'une brève description du défaut et d'un ticket de caisse ou d'une facture portant la date d'achat et le cachet du vendeur.

Service de réparation : une fois la garantie écoulee ou en cas de défauts non couverts par la garantie, contactez votre point de service après-vente pour savoir si une remise en état de l'appareil est possible.

3 A N S
DE GARANTIE
FABRICANT

10. Caractéristiques techniques

- Dimensions (H × l × P) : 95 × 95 × 38 mm
- Raccordement au secteur : 220-240 V, 50/60 Hz
- Consommation électrique : *NightmatIQ* < 0,7 W
NightmatIQ plus < 0,5 W
- Réglage du seuil de déclenchement :
NightmatIQ : de 1 à 75 lx
NightmatIQ plus : de 1 à 1000 lx
- Technologie de détection : phototransistor
- Plage de températures : de -20 à +40 °C
- Fréquence Bluetooth
(seulement pour *NightmatIQ plus*) : de 2,4 à 2,48 GHz
- Puissance d'émission Bluetooth
(seulement pour *NightmatIQ plus*) : 4 dBm/2,5 mW
- Indice de protection : IP 54

Puissance de commutation

- Lampes à incandescence / halogènes : 1000 W
- Lampes halogènes basse tension : 1000 VA
- Tubes fluorescents non compensés : 500 VA
- Tubes fluorescents compensés par série : 500 VA
- Tubes fluorescents compensés en parallèle : 500 VA
- Tubes fluorescents ballasts électroniques : 250 W
- Lampes LED <2 W : 100 W
- Lampes LED >2 W <8W : 125 W
- Lampes LED >8 W : 250 W
- Charge capacitive : 88 µF

11. Élimination des défauts

L'appareil n'est pas sous tension.

- Fusible non enclenché ou défectueux.
 - Enclencher le fusible.
 - Remplacer le fusible défectueux.
- Câble coupé.
 - Vérifier le câble à l'aide d'un testeur de tension.
- Court-circuit dans le câble secteur.
 - Vérifier les branchements.
- L'interrupteur secteur éventuellement présent en position arrêt.
 - Mettre l'interrupteur secteur en position MARCHE.

L'appareil ne s'allume pas.

- Mauvais choix du réglage du seuil de déclenchement.
 - Régler à nouveau le seuil de déclenchement.
- Interrupteur secteur en position ARRÊT.
 - Mettre l'interrupteur secteur en position MARCHE.
- Fusible non enclenché ou défectueux.
 - Enclencher le fusible.
 - Remplacer le fusible défectueux.

Inhoud

1.	Over dit document	3
2.	Algemene veiligheidsvoorschriften	3
3.	Beschrijving van het apparaat	4
4.	Elektrische aansluiting	9
5.	Montage	10
6.	Werking	19
7.	Schoonmaken en verzorgen	24
8.	Verwijderen	24
9.	Fabrieksgarantie	25
10.	Technische gegevens	26
11.	Verhelpen van storingen	27

1. Over dit document

- Rechten uit het auteursrecht voorbehouden. Vermenigvuldiging, ook van delen van deze handleiding, is alleen met onze toestemming geoorloofd.
- Wijzigingen in het kader van de technische vooruitgang voorbehouden.



Waarschuwing voor gevaar!



Waarschuwing voor risico's door elektriciteit!



Waarschuwing voor risico's door water!

2. Algemene veiligheidsvoorschriften



Gevaar door niet naleving van de gebruiksaanwijzing!

Deze gebruiksaanwijzing bevat belangrijke informatie inzake een veilige omgang met het apparaat. Er wordt in het bijzonder gewezen op mogelijke risico's. Indien deze informatie niet wordt nageleefd kan dit ernstig lichamelijk letsel en zelfs de dood tot gevolg hebben.

- Gebruiksaanwijzing zorgvuldig doorlezen.
- Veiligheidsvoorschriften naleven.
- Toegankelijk bewaren.
- Door de omgang met elektrische stroom kunnen gevaarlijke situaties ontstaan. Het aanraken van stroomvoerende componenten kan een elektrische schok, verbrandingen of zelfs de dood tot gevolg hebben.
- Werkzaamheden aan de netspanning mogen uitsluitend door gekwalificeerd vakpersoneel worden uitgevoerd.
- De nationale installatievoorschriften en aansluitvoorwaarden moeten worden nageleefd (bijv. DE: VDE 0100, AT: ÖVE-ÖNORM E8001-1, CH: SEV 1000).

- Gebruik uitsluitend originele reserveonderdelen.
- Reparaties mogen uitsluitend door een vakbedrijf worden uitgevoerd.

3. Beschrijving van het apparaat

Gebruik volgens de voorschriften NighmatIQ

- Schemerschakelaar, geschikt voor wandmontage binnen en buiten.
- De functie schemerinstelling kan via de potentiometer worden ingesteld.
- Kan als losse sensor worden gebruikt.

Gebruik volgens de voorschriften NighmatIQ Plus

- Schemerschakelaar, geschikt voor wandmontage binnen en buiten.
- Functies kunnen met de Steinel Connect app worden ingesteld.
- Kan als losse sensor of met Bluetooth-koppeling worden gebruikt.

Functieprincipe

- De schemerschakelaar registreert met behulp van de lichtsensor de omgevingslichtsterkte en vergelijkt die met de ingestelde drempelwaarde.
- Wanneer de omgevingslichtsterkte onder de drempelwaarde ligt, wordt de aangesloten verbruiker ingeschakeld.
- Als de omgevingslichtsterkte boven de drempelwaarde ligt, wordt de aangesloten verbruiker uitgeschakeld.

Leveringsomvang NightmatIQ / NightmatIQ Plus

3.1

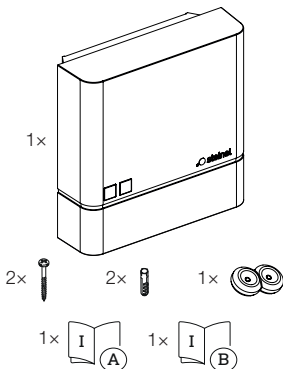

- 1 NightmatIQ / NightmatIQ Plus
- 2 schroeven
- 2 pluggen
- 1 afdichtstopje
- 1 veiligheidsinformatieblad
- 1 Quick-Start

3.2

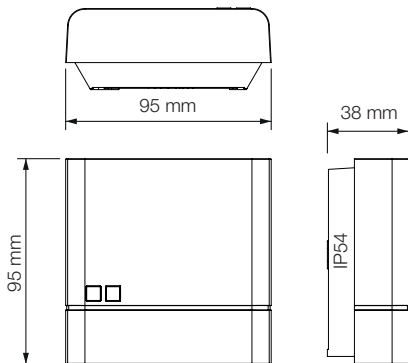

Overzicht NightmatIQ

3.3

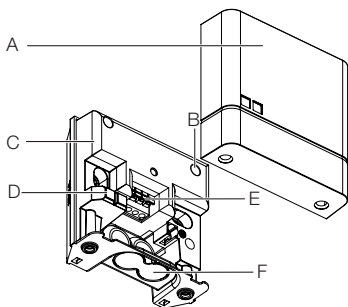

- A Afdekking
- B Potentiometer schemerinstelling
- C Behuizing schemerschakelaar
- D Lichtsterktesensor
- E Aansluitklem
- F Optionele opening bij bekabeling op de muur

3.4



- G Detail: potentiometer schemerinstelling

Overzicht NightmatIQ Plus

3.5

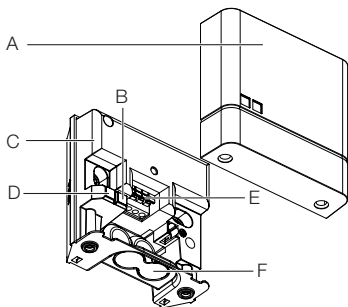

- A Afdekking
- B Status-led-lampje
- C Behuizing schemerschakelaar
- D Lichtsterktesensor
- E Aansluitklem
- F Optionele opening bij bekabeling op de muur

4. Elektrische aansluiting

Schakelschema

4.1

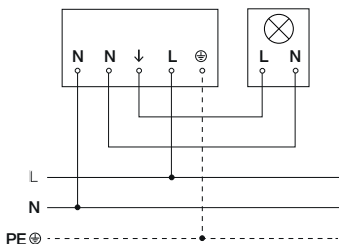

De stroomtoevoer bestaat uit een 3-polige kabel:

- L** = fase (meestal zwart, bruin of grijs)
- N** = nuldraad (meestal blauw)
- PE** = aarde (groen/geel)

Het apparaat kan ook elektrisch worden aangesloten achter een netschakelaar, indien gewaarborgd is dat de netschakelaar continu is ingeschakeld.

De afdichtdopjes zijn bedoeld voor netspanningskabels met een uitwendige diameter van 5-10 mm.

5. Montage



Gevaar door elektrische stroom!

Het aanraken van stroomvoerende componenten kan een elektrische schok, verbrandingen of zelfs de dood tot gevolg hebben.

- De stroom uitschakelen en de spanningstoevoer onderbreken.
- Controleer m.b.v. een spanningstester dat er geen spanning op staat.
- Zorg ervoor dat de spanningstoevoer onderbroken blijft.

Gevaar voor beschadigingen!

Het verwisselen van de kabels kan kortsluiting tot gevolg hebben.

- Identificeer de aansluitkabels.
- Aansluitkabels correct verbinden.

Montagevoorbereiding

- Alle onderdelen controleren op beschadigingen. Neem het apparaat bij beschadigingen niet in gebruik.
- Geschikte montageplaats kiezen.
 - Trillingsvrij.
 - Niet in een explosieve omgeving monteren.
 - Niet op licht ontvlambare oppervlakken monteren.
 - Het apparaat mag niet worden beïnvloed door het licht van de aangesloten gebruiker.

Montagestappen

5.1

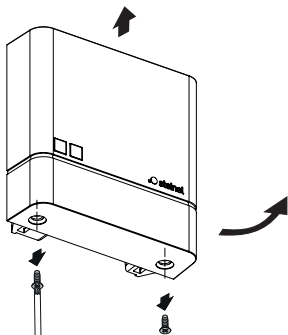

- Stroomtoevoer uitschakelen
- Controleer of de spanningstoevoer is uitgeschakeld.
- Afdekking losschroeven en verwijderen.

5.2

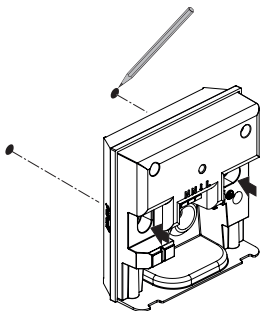

- Boorgaten aftekenen.

5.3

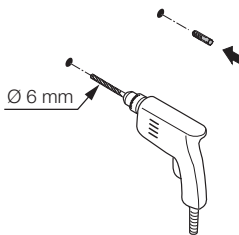

- Gaten boren (ø 6 mm) en pluggen inbrengen.

5.4

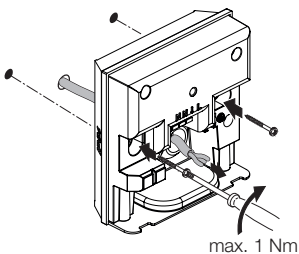

- Kabel door het apparaat voeren.
- Apparaat met een aandraaimoment van max. 1 Nm vastschroeven.

Opbouwvariant

5.5

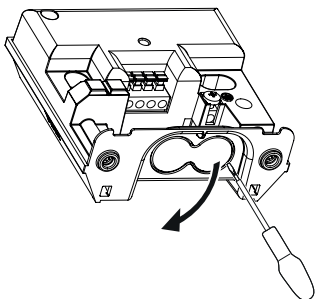

- De optionele opening voor bekabeling op de muur voorzichtig doordrukken met een schroevendraaier.

5.6



- Afdichtstopje plaatsen

5.7

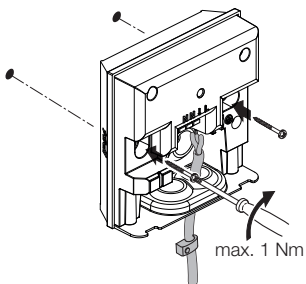

- Kabel door het apparaat voeren.
- Apparaat met een aandraaimoment van max. 1 Nm vastschroeven.

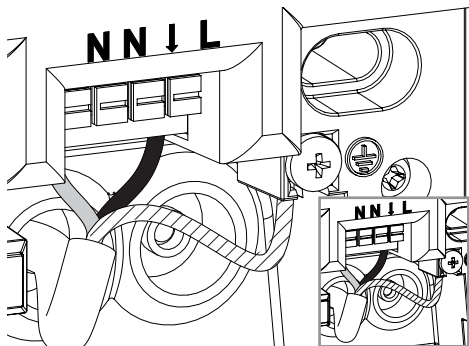

- Stroomtoevoer volgens schakelschema aansluiten.
→ „4. Elektrische aansluiting“

5.9

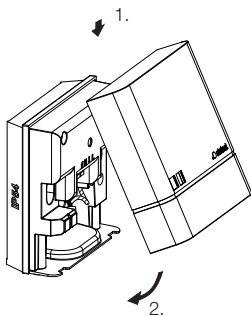

- Afdekkap plaatsen.

5.10

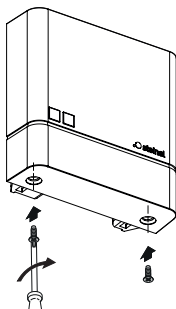

- Afdekking vastschroeven.



- Stroomtoevoer inschakelen.
 - Functies instellen.
- „6. Werking“

6. Werking

NightmatIQ

Bij de NightmatIQ wordt de schemerinstelling met de hand ingesteld via de potentiometer schemerinstelling.



Gevaar door elektrische stroom!

Het aanraken van stroomvoerende componenten kan een elektrische schok, verbrandingen of zelfs de dood tot gevolg hebben.

- De stroom uitschakelen en de spanningstoevoer onderbreken.
 - Controleer m.b.v. een spanningstester dat er geen spanning op staat.
 - Zorg ervoor dat de spanningstoevoer onderbroken blijft.
-
- **Fabrieksinstellingen**
 - Schemerinstelling: 75 lux

Schemerinstelling (G)

De inschakellichtsterkte (schemering) kan traploos van ca. 1-75 lux worden ingesteld.

- ☀ = schemerstand (ca. 75 lux)
- ☾ = schemerstand/nachtstand (ca. 1 lux)

Handmatige schemerinstelling NightmatIQ

6.1

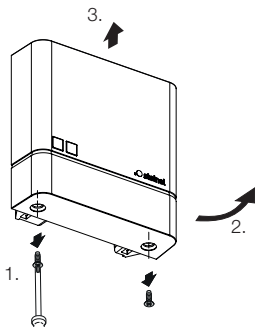

- Stroomtoevoer uitschakelen
- Controleer of de spanningtoevoer is uitgeschakeld.
- Afdekking losschroeven.

6.2

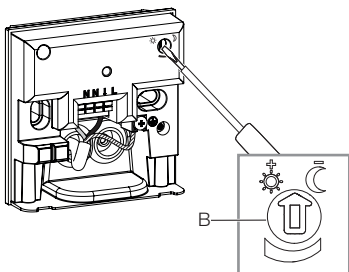

- De gewenste drempelwaarde voor de schemerinstelling traploos instellen met de schroevendraaier.

6.3

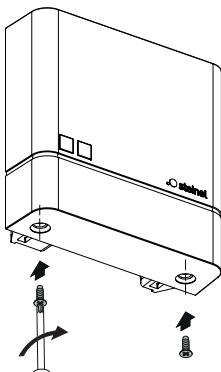

- Afdekking vastschroeven.

6.4



- Stroomtoevoer inschakelen.

NightmatIQ Plus

Bij de NightmatIQ Plus worden de functies via de Steinel Connect app ingesteld.

Steinel Connect app

Voor de configuratie van de lamp m.b.v. smartphone of tablet moet de STEINEL Connect app uit de AppStore worden gedownload. Hiervoor is een voor Bluetooth geschikt(e) smartphone of tablet vereist.



Android



iOS



Functies die met de Steinel Connect app kunnen worden ingesteld:

- Schemerinstelling.

Opmerking:

Er moet een minimumafstand van 3 m tot de WLAN-router en de Access Points worden aangehouden om storingen te voorkomen.

Led-functie

Initialiseren: led brandt continu.

Normaal bedrijf: led uit.

Identificatie: led knippert langzaam.

Firmware update: led knippert snel.

Fout: led knippert snel.

Fabrieksinstellingen

- Schemerinstelling: 1.000 lux

Schemerinstelling

De inschakellichtsterkte (schemering) kan traploos van ca. 1-1.000 lux worden ingesteld.

- ☀ = schemerstand (ca. 1.000 lux)
- ☾ = schemerstand/nachtstand (ca. 1 lux)

Bluetooth-koppeling (Bluetooth Mesh)

De sensorschakelaar voldoet aan de Bluetooth Mesh Standard. Hij kan gekoppeld worden aan alle producten die aan de Bluetooth Mesh Standard voldoen.

Het configureren van de sensorschakelaar wordt met de Steinel Connect app uitgevoerd. Bij de eerste verbinding tussen sensorschakelaar en Steinel Connect App worden de bijbehorende netwerksleutels opgeslagen op uw smartphone of tablet. Dankzij deze sleutels is uitgesloten dat onbevoegden toegang krijgen tot de sensor.

Om met een extra smartphone of tablet toegang te krijgen, moet de netwerksleutel worden gedeeld.

Schakeltijden

Behalve het instellen van de schemerwaarde kunnen met de app ook schakeltijden worden ingesteld waarin aangesloten verbruikers AAN of UIT moeten worden gezet.

Hiervoor ontvangt de NightmatIQ plus via een Bluetooth-verbinding met een mobiele telefoon/tablet de actuele tijd en gebruikt die voor toekomstige schakelingen.

Wanneer de stroomtoevoer van de NightmatIQ plus wordt onderbroken, gaat de opgeslagen tijd verloren. De NightmatIQ plus bepaalt de tijd op basis van het zonverloop van de afgelopen dagen bij benadering. Om de exacte tijd weer te kunnen herstellen, is een nieuwe verbinding met de app nodig.

7. Schoonmaken en verzorgen

Dit apparaat is onderhoudsvrij.



Gevaar door elektrische stroom!

Het contact van water met stroomvoerende componenten kan een elektrische schok, verbrandingen of zelfs de dood tot gevolg hebben.

- Reinig het apparaat alleen in droge toestand.

Gevaar voor beschadigingen!

De lamp kan door het gebruiken van verkeerde schoonmaakmiddelen worden beschadigd.

- Reinig het apparaat met een licht bevochtigde doek zonder reinigingsmiddel.

8. Verwijderen

Elektrische apparaten, batterijen, accessoires en verpakkingen moeten op milieuvriendelijke wijze gerecycled worden.



Afgedankte elektrische apparaten en oude batterijen horen niet bij het huisvuil!

Alleen voor EU-landen:

Conform de geldende Europese richtlijn betreffende afgedankte elektrische en elektronische apparatuur en de implementatie hiervan in nationaal recht moeten afgedankte elektrische apparaten en batterijen gescheiden ingezameld en op milieuvriendelijke wijze gerecycled worden.

9. Fabrieksgarantie

Dit Steinel-product is met grote zorgvuldigheid gefabriceerd, getest op goede werking en veiligheid volgens de geldende voorschriften en vervolgens steekproefsgewijs gecontroleerd. Steinel verleent garantie op de storingvrije werking. De garantietermijn bedraagt 36 maanden en gaat in op de datum van aanschaf door de klant. Wij verhelpen gebreken die berusten op materiaal- of productiefouten. De garantie bestaat uit reparatie of vernieuwen van de defecte onderdelen, door ons te beoordelen. Garantie vervalt bij schade aan onderdelen, die aan slijtage onderhevig zijn en bij schade of gebreken, die door ondeskundig gebruik of onderhoud ontstaan. Schade aan andere voorwerpen is uitgesloten van garantie.

De garantie wordt alleen verleend wanneer het niet-gedemonteerde apparaat met korte storingsbeschrijving, kassabon of rekening (koopdatum en winkelierstempel), goed verpakt naar het desbetreffende serviceadres wordt gestuurd.

Reparatieservice:

Na afloop van de garantieduur of bij gebreken die niet onder de garantie vallen, kunt u het dichtstbijzijnde serviceadres naar de mogelijkheden van een reparatie vragen.

3 JAAR
FABRIEKS
GARANTIE

10. Technische gegevens

- Afmetingen (H x B x D): 95 x 95 x 38 mm
- Netaansluiting: 220-240 V, 50/60 Hz
- Opgenomen vermogen: *NightmatIQ* < 0,7 W
NightmatIQ plus < 0,5 W
- Schemerinstelling: *NightmatIQ*: 1-75 lux
NightmatIQ plus: 1-1.000 lux
- Sensortechniek: phototransistor
- Temperatuurbereik: -20 tot +40 °C
- Frequentie Bluetooth (alleen *NightmatIQ plus*): 2,4-2,48 GHz
- Zendvermogen Bluetooth (alleen *NightmatIQ plus*): 4 dBm/2,5 mW
- Bescherming: IP 54

Schakelvermogen

- Gloei-/halogeenlampen: 1.000 W
- Halogeenlampen, laag voltage: 1.000 VA
- TI-lampen ongecompenseerd: 500 VA
- TI-lampen seriegecompenseerd: 500 VA
- TI-lampen parallel gecompenseerd: 500 VA
- TI-lampen elektronische voorschakelapparaten: 250 W
- Led-lampen <2W: 100 W
- Led-lampen >2W <8W: 125 W
- Led-lampen >8W: 250 W
- Capaciteve belasting: 88 µF

11. Verhelpen van storingen

Apparaat zonder spanning.

- Zekering niet ingeschakeld of defect.
 - Zekering inschakelen.
 - Defecte zekering vervangen.
- Kabel onderbroken.
 - Kabel testen met spanningstester.
- Kortsluiting in de stroomtoevoer.
 - Aansluitingen controleren.
- Eventueel aanwezige netschakelaar uit.
 - Netschakelaar inschakelen.

De lamp schakelt niet in.

- Schemerinstelling verkeerd gekozen.
 - Schemerinstelling opnieuw instellen.
- Netschakelaar UIT.
 - Netschakelaar instellen.
- Zekering niet ingeschakeld of defect.
 - Zekering inschakelen.
 - Defecte zekering vervangen.

Sommario

1.	Riguardo a questo documento	3
2.	Avvertenze generali relative alla sicurezza	3
3.	Descrizione apparecchio	4
4.	Allacciamento elettrico	9
5.	Montaggio	10
6.	Funzionamento	19
7.	Pulizia e cura	24
8.	Smaltimento	24
9.	Garanzia del produttore	25
10.	Dati tecnici	26
11.	Eliminazione dei guasti	27

1. Riguardo a questo documento

- Tutelato dai diritti d'autore. La ristampa, anche solo di estratti, è consentita solo previa nostra approvazione.
- Con riserva di modifiche legate ai progressi della tecnologia.



Avvertimento contro pericoli!



Avvertimento contro pericoli dovuti alla corrente elettrica!



Avvertimento contro pericoli dovuti all'acqua!

2. Avvertenze generali relative alla sicurezza



Pericolo in caso d'inosservanza delle istruzioni per l'uso!

Le presenti istruzioni per l'uso contengono importanti informazioni per un utilizzo sicuro dell'apparecchio. Vengono fatti particolarmente presenti i possibili pericoli. L'inottemperanza alle istruzioni potrebbe portare alla morte o a gravi lesioni.

- Leggere attentamente le istruzioni.
- Seguire le avvertenze sulla sicurezza.
- Conservare le istruzioni in un luogo facilmente accessibile.
- Nei lavori legati alla corrente elettrica si potrebbero verificare situazioni pericolose. Il contatto con parti conduttive potrebbe provocare una scossa elettrica, ustioni o addirittura la morte.
- I lavori sulla tensione di rete possono essere eseguiti esclusivamente da personale specializzato e qualificato.
- Si devono osservare le condizioni di allacciamento e le norme nazionali in materia d'installazione (per es. DE: VDE 0100, AT: ÖVE-ÖNORM E8001-1, CH: SEV 1000).

- Utilizzare esclusivamente pezzi di ricambio originali.
- Sono consentite riparazioni solo da parte di aziende specializzate.

3. Descrizione apparecchio

Utilizzo adeguato allo scopo NighmatIQ

- Interruttore crepuscolare per il montaggio a muro in ambienti interni ed esterni.
- Funzione della regolazione crepuscolare regolabile tramite potenziometro.
- Utilizzabile come sensore singolo.

Utilizzo adeguato allo scopo NighmatIQ Plus

- Interruttore crepuscolare per il montaggio a muro in ambienti interni ed esterni.
- Funzioni impostabili tramite la app Steinel Connect.
- Utilizzabile come sensore singolo o collegato con Bluetooth.

Principio di funzionamento

- L'interruttore crepuscolare rileva, con l'ausilio del sensore ottico, la luminosità dell'ambiente e la confronta con il valore soglia di luminosità impostato.
- Se la luminosità dell'ambiente si trova al di sotto del valore soglia, l'utenza allacciata viene attivata.
- Se la luminosità dell'ambiente si trova al di sopra del valore soglia, l'utenza allacciata viene disttivate.

3.1

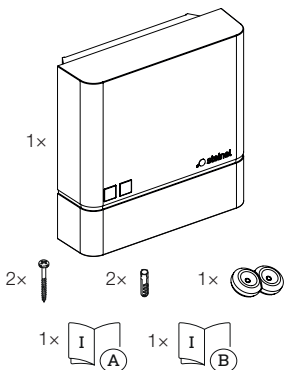

- 1 NightmatIQ / NightmatIQ Plus
- 2 viti
- 2 tasselli
- 1 tappo di tenuta
- 1 scheda dati sulla sicurezza
- 1 avvio rapido

Dimensioni del prodotto NightmatIQ / NightmatIQ Plus

3.2

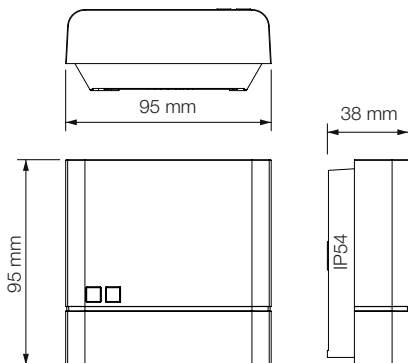

Panoramica dell'apparecchio NightmatIQ

3.3

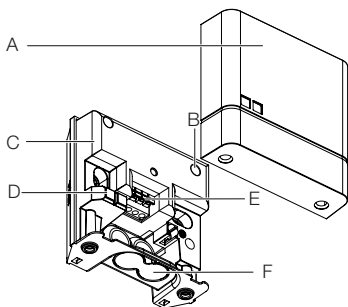

- A Copertura
- B Potenzimetro regolazione crepuscolare
- C Involucro interruttore crepuscolare
- D Sensore della luminosità
- E Morsettieria di allacciamento
- F Apertura opzionale per cablaggio in superficie

3.4



- G Dettaglio: potenziometro regolazione crepuscolare

Panoramica dell'apparecchio NightmatIQ Plus

3.5

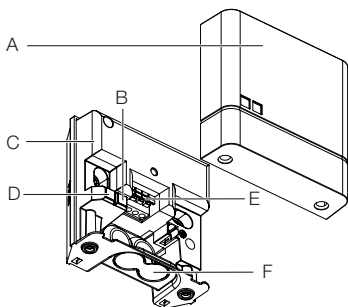

- A Copertura
- B LED di stato
- C Involucro interruttore crepuscolare
- D Sensore della luminosità
- E Morsetti di allacciamento
- F Apertura opzionale per cablaggio in superficie

4. Allacciamento elettrico

Schema elettrico

4.1

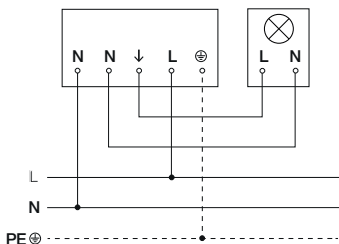

Il cavo di collegamento alla rete ha 3 fili.

L = fase (di prevalenza nero, marrone o grigio)

N = filo neutro (di prevalenza blu)

PE = conduttore di terra (verde/giallo)

L'apparecchio può anche essere allacciato elettricamente a valle di un interruttore di rete, purché sia garantito che quest'ultimo rimanga sempre acceso.

I tappi di tenuta sono previsti per una linea di allacciamento alla rete con un diametro esterno di 5-10 mm.

5. Montaggio



Pericolo legato alla presenza di corrente elettrica!

Il contatto con parti conduttive potrebbe provocare una scossa elettrica, ustioni o addirittura la morte.

- Staccare la corrente e interrompere la tensione di alimentazione di rete.
- Accertarsi dell'assenza di tensione con un indicatore di tensione.
- Provvedere affinché l'alimentazione della rete elettrica rimanga interrotta.

Pericolo di danni a cose!

Uno scambio dei cavi di allacciamento potrebbe provocare un cortocircuito.

- Contrassegnare i cavi di allacciamento in modo da poterli identificare.
- Collegare correttamente i cavi di allacciamento.

Preparazione del montaggio

- Controllare tutti i componenti per verificare se presentano danneggiamenti. In caso di danni non mettere in funzione l'apparecchio.
- Selezionare il luogo di montaggio adatto.
 - Protetto da vibrazioni.
 - Non in aree a rischio di esplosione.
 - Non su superfici facilmente infiammabili.
 - L'apparecchio non deve essere influenzato dalla luce delle utenze collegate.

Fasi di montaggio

5.1

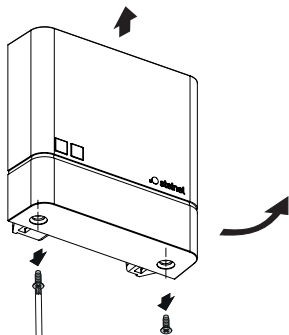

- Staccare l'alimentazione di corrente.
- Accertarsi che la tensione di alimentazione di rete sia disattivata.
- Svitare e sfilare la copertura.

5.2

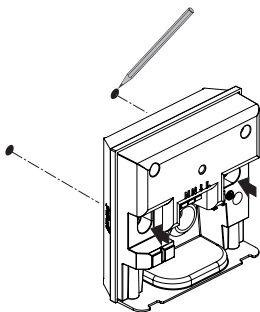

- Segnare i fori.

5.3

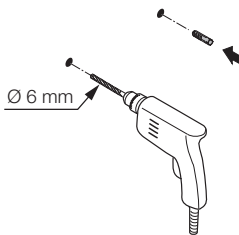

- Effettuare i fori (\varnothing 6 mm) e inserire i tasselli.

Variante incassata

5.4

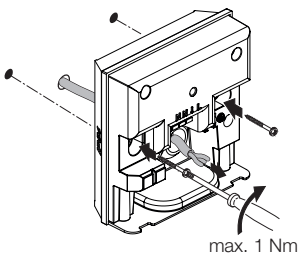

- Far passare il cavo attraverso l'apparecchio.
- Avvitare l'apparecchio con una coppia massima pari a 1 Nm.

Variante in superficie

5.5

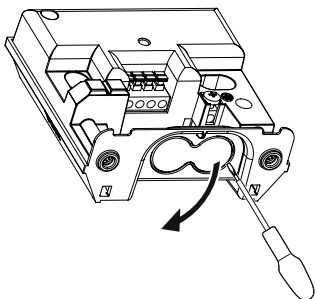

- Aprire l'apertura opzionale per cablaggio in superficie rompendo la copertura con cautela tramite un cacciavite.

5.6

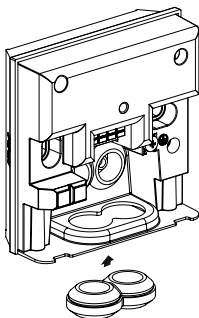

- Inserire il tappo di tenuta

5.7

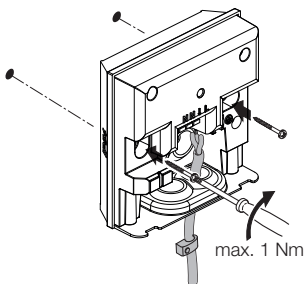

- Far passare il cavo attraverso l'apparecchio.
- Avvitare l'apparecchio con una coppia massima pari a 1 Nm.

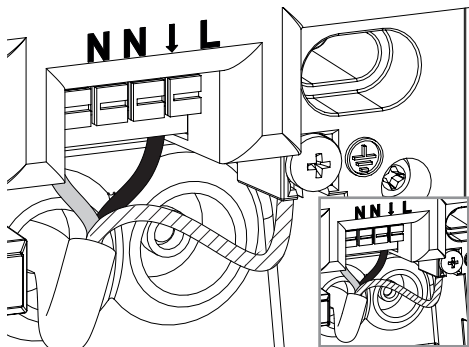

- Allacciare il cavo di rete secondo quanto indicato nello schema elettrico.

→ „4. Allacciamento elettrico“

5.9

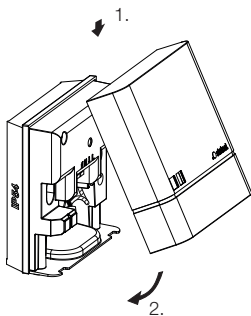

- Applicare la copertura.

5.10

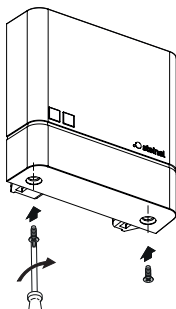

- Avvitare la copertura.



- Attivare l'alimentazione della rete elettrica.
 - Impostare le funzioni.
- „6. Funzionamento“

6. Funzionamento

NightmatIQ

Nel caso di NightmatIQ la regolazione crepuscolare viene effettuata manualmente tramite il potenziometro regolazione crepuscolare.



Pericolo legato alla presenza di corrente elettrica!

Il contatto con parti conduttive potrebbe provocare una scossa elettrica, ustioni o addirittura la morte.

- Staccare la corrente e interrompere la tensione di alimentazione di rete.
- Accertarsi dell'assenza di tensione con un indicatore di tensione.
- Provvedere affinché l'alimentazione della rete elettrica rimanga interrotta.

- **Impostazioni di fabbrica**

- Regolazione crepuscolare: 75 Lux

Regolazione crepuscolare (G)

La soglia d'intervento (luce crepuscolare) può essere imposta in continuo tra ca. 1 e 75 Lux.

- ☀ = funzionamento crepuscolare (ca. 75 Lux)
- ☾ = funzionamento crepuscolare/funzionamento nel buio notturno (ca. 1 Lux)

Regolazione crepuscolare manuale NightmatIQ

6.1

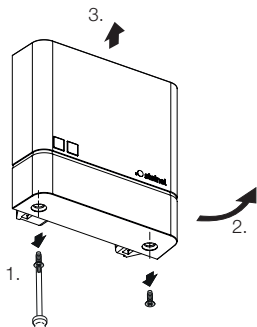

- Staccare l'alimentazione di corrente.
- Accertarsi che la tensione di alimentazione di rete sia disattivata.
- Svitare la copertura.

6.2

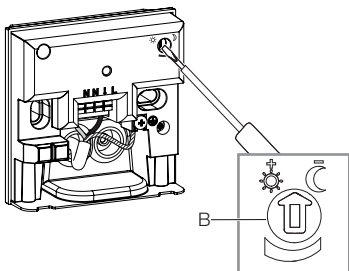

- Regolare in continuo con il cacciavite la soglia d'intervento desiderata della regolazione crepuscolare.

6.3

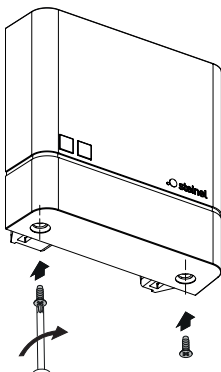

- Avvitare la copertura.

6.4



- Attivare l'alimentazione della rete elettrica.

NightmatIQ Plus

Nel caso di NightmatIQ Plus l'impostazione delle funzioni avviene tramite la app Steinel Connect.

Steinel Connect App

Per la configurazione dell'apparecchio con smartphone o tablet dovete scaricare la app STEINEL Connect dal Vostro AppStore. A tale scopo è necessario uno smartphone o tablet.



Android



iOS



Funzioni impostabili tramite la app Steinel Connect:

- Regolazione crepuscolare.

Avvertenza:

Al fine di escludere malfunzionamenti, si deve rispettare una distanza minima di 3 m dal router WLAN e dagli Access Points.

Funzione LED

Inizializzazione: il LED è acceso permanentemente.

Funzionamento normale: il LED è spento.

Identificazione: il LED lampeggia lentamente.

Update del firmware: il LED lampeggia rapidamente.

Errore: il LED lampeggia rapidamente.

Impostazioni di fabbrica

- Regolazione crepuscolare: 1.000 Lux

Regolazione crepuscolare

La soglia d'intervento (luce crepuscolare) può essere impostata in continuo tra ca. 1 e 1.000 Lux.

- ☀ = funzionamento crepuscolare (ca. 1.000 Lux)
- ☾ = funzionamento crepuscolare/funzionamento nel buio notturno (ca. 1 Lux)

Collegamento Bluetooth (Bluetooth Mesh)

L'interruttore a sensore corrisponde al Bluetooth Mesh Standard. Esso può essere collegato con tutti i prodotti conformi al Bluetooth Mesh Standard.

La configurazione dell'interruttore a sensore avviene tramite la app Steinel Connect. Al primo collegamento tra l'interruttore a sensore e la app Steinel Connect vengono memorizzate sullo smartphone o il tablet relative chiavi di rete. La chiave consente di escludere un accesso al sensore da parte di persone non autorizzate.

Per l'accesso tramite un altro smartphone o tablet occorre che la chiave di rete venga condivisa.

Ore di accensione

Oltre all'impostazione relativa al valore crepuscolare, tramite la app si possono impostare anche le ore di accensione in cui si desidera che le utenze collegate vengano accese o spente.

NightmatIQ Plus grazie al collegamento Bluetooth con uno smartphone/tablet riceve l'ora attuale e la utilizza per la futura azione di accensione/spegnimento.

Se l'alimentazione di tensione a NighmatIQ Plus viene interrotta, l'ora memorizzata si perde. Sulla base dell'andamento del sole nelle giornate precedenti, NighmatIQ Plus rileva un'ora approssimata. Per ripristinare l'ora esatta è necessario un nuovo collegamento con la app.

7. Pulizia e cura

L'apparecchio non necessita di manutenzione.



Pericolo legato alla presenza di corrente elettrica!

Il contatto di parti conduttive con acqua può provocare una scossa elettrica, ustioni o addirittura la morte.

- Pulire l'apparecchio solo quando è asciutto.

Pericolo di danni a cose!

Detergenti sbagliati potrebbero danneggiare l'apparecchio.

- Pulire l'apparecchio con un panno leggermente inumidito, senza detersivi.

8. Smaltimento

Apparecchi elettrici, pile, accessori e materiali d'imballaggio devono essere consegnati a un centro di riciclaggio riconosciuto.



Non gettate gli apparecchi elettrici e le pile assieme ai rifiuti domestici!

Solo per paesi UE:

conformemente alla Direttiva Europea vigente in materia di rifiuti di apparecchi elettrici ed elettronici e alla sua attuazione nel diritto nazionale, le pile e gli apparecchi elettrici ed elettronici non più idonei all'uso devono essere separati dagli altri rifiuti e consegnati a un centro di riciclaggio riconosciuto.

9. Garanzia del produttore

Questo prodotto STEINEL viene costruito con la massima cura, con controlli di funzionamento e del grado di sicurezza in conformità alle norme vigenti in materia; vengono poi effettuati collaudi con prove a campione. STEINEL si assume la garanzia di una fabbricazione ed un funzionamento perfetti. La garanzia si estende a 36 mesi ed inizia il giorno d'acquisto da parte dell'utilizzatore finale. Noi eliminiamo difetti riconducibili al materiale o alla fabbricazione; la prestazione della garanzia consiste a nostra discrezione nella riparazione o nella sostituzione dei pezzi difettosi. Il diritto alla prestazione di garanzia viene a decadere in caso di danni a pezzi soggetti ad usura nonché in caso di danni o difetti che sono da ricondurre ad un trattamento inadeguato o ad una cattiva manutenzione. Sono esclusi dal diritto di garanzia gli ulteriori danni conseguenti che si verificano su oggetti estranei.

La garanzia viene prestata solo se l'apparecchio viene inviato non smontato, ben imballato e accompagnato da una breve descrizione del difetto e dallo scontrino o dalla fattura (in cui siano indicati la data dell'acquisto e il timbro del rivenditore), al centro di assistenza competente.

Centro assistenza riparazioni:

Dopo la scadenza del periodo di garanzia o in caso di difetti per i quali non si ha diritto alla prestazione di garanzia, siete pregati di rivolgerVi al centro di assistenza più vicino per informarVi sulla possibilità di riparazione.

3 ANNI
DI GARANZIA
DEL PRODUTTORE

10. Dati tecnici

- Dimensioni (A x L x P): *95 x 95 x 38 mm*
- Allacciamento alla rete: *220-240 V, 50/60 Hz*
- Potenza assorbita: *NightmatIQ < 0,7 W*
NightmatIQ Plus < 0,5 W
- Regolazione crepuscolare: *NightmatIQ: 1-75 Lux*
NightmatIQ Plus: 1-1.000 Lux
- Sensori: *fototransistor*
- Campo di temperatura: *tra -20 e +40 °C*
- Frequenza Bluetooth (solo NightmatIQ Plus):
2,4-2,48 GHz
- Potenza di trasmissione Bluetooth
(solo NightmatIQ Plus): *4 dBm/2,5 mW*
- Grado di protezione: *IP 54*

Potere d'interruzione

- Carico lampadine incandescenti / lampade alogene: *1.000 W*
- Lampade alogene a basso voltaggio: *1.000 VA*
- Lampade fluorescenti non compensato: *500 VA*
- Lampade fluorescenti compensato in serie: *500 VA*
- Lampade fluorescenti compensato in parallelo: *500 VA*
- Lampade fluorescenti ballast elettronico: *250 W*
- Lampade LED <2W: *100 W*
- Lampade LED >2W <8W: *125 W*
- Lampade LED >8W: *250 W*
- Carico capacitivo: *88 µF*

11. Eliminazione dei guasti

Apparecchio senza tensione.

- Il fusibile non è integro o è difettoso.
 - Controllare il fusibile.
 - Sostituire il fusibile difettoso.
- Linea interrotta.
 - Controllare il cavo con un indicatore di tensione.
- Corto circuito nel cavo di collegamento alla rete.
 - Controllare gli allacciamenti.
- Eventuale interruttore di rete spento.
 - Accendere l'interruttore di rete.

L'apparecchio non si accende.

- La regolazione crepuscolare scelta è troppo bassa.
 - Reimpostare la regolazione crepuscolare.
- Interruttore di rete spento.
 - Attivare l'interruttore di rete.
- Il fusibile è difettoso.
 - Controllare il fusibile.
 - Sostituire il fusibile difettoso.

Índice

1.	Acerca de este documento	3
2.	Indicaciones generales de seguridad	3
3.	Descripción del aparato	4
4.	Conexión eléctrica	9
5.	Montaje	10
6.	Funciones	19
7.	Limpieza y cuidados	24
8.	Eliminación	24
9.	Garantía de fabricante	25
10.	Datos técnicos	26
11.	Reparación de averías	27

1. Acerca de este documento

- Protegido por derechos de autor. Queda terminantemente prohibida la reimpresión, ya sea total o parcial, salvo con autorización expresa.
- Sujeto a modificaciones en función del progreso técnico.



¡Advertencia de peligros!



¡Advertencia de peligros por corriente eléctrica!



¡Advertencia de peligros por agua!

2. Indicaciones generales de seguridad



¡Peligro por la no observación de las instrucciones de uso!

Estas instrucciones contienen información importante sobre el manejo seguro del aparato. Se advierte especialmente de posibles peligros. La no observancia puede causar la muerte o lesiones graves.

- Léanse las instrucciones detenidamente.
- Cúmplanse las indicaciones de seguridad.
- Manténgase al alcance.
- El manejo de la corriente eléctrica puede causar situaciones peligrosas. El contacto físico con piezas conductoras de electricidad puede causar shocks eléctricos, quemaduras o la muerte.
- El trabajo en la tensión eléctrica deberá ser realizado exclusivamente por personal técnico especializado.
- Se cumplirán las normativas de instalación y los requisitos de acometida específicos de cada país (p. ej., DE: VDE 0100, AT: ÖVE-ÖNORM E8001-1, CH: SEV 1000).
- Utilice solo piezas de repuesto originales.

- Las reparaciones solo están permitidas a empresas especializadas.

3. Descripción del aparato

Uso previsto NighmatIQ

- Interruptor crepuscular, apto para el montaje en la pared en el interior y exterior.
- Función regulación crepuscular ajustable vía potenciómetro.
- Utilizable como sensor particular.

Uso previsto NighmatIQ Plus

- Interruptor crepuscular, apto para el montaje en la pared en el interior y exterior.
- Funciones ajustables vía aplicación Steinel Connect.
- Utilizable como sensor particular o interconectado vía Bluetooth.

Principio funcional

- El interruptor crepuscular registra la luminosidad ambiental mediante el fotosensor y la compara con el umbral de luminosidad ajustado.
- Si la luminosidad ambiental es inferior al umbral de luminosidad, el consumidor conectado se enciende.
- Si la luminosidad ambiental es superior al umbral de luminosidad, el consumidor conectado se apaga.

Volumen de suministro NightmatIQ / NightmatIQ Plus

3.1

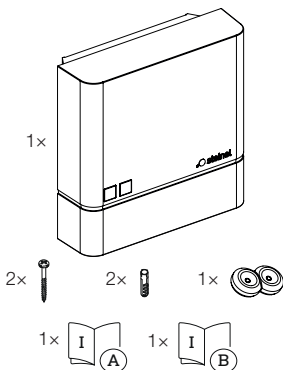

- 1 NightmatIQ / NightmatIQ Plus
- 2 tornillos
- 2 espigas
- 1 tapón obturador
- 1 hoja de datos de seguridad
- 1 guía rápida

Dimensiones del producto NightmatIQ / NightmatIQ Plus

3.2

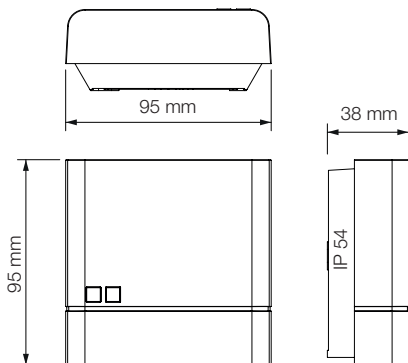

Visión general del equipo NightmatIQ

3.3

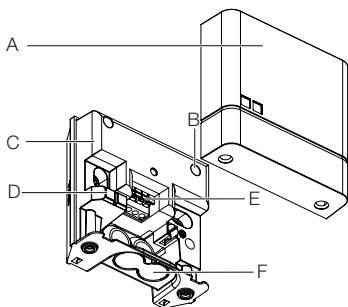

- A Cubierta
- B Potenciómetro regulación crepuscular
- C Carcasa interruptor crepuscular
- D Sensor de luminosidad
- E Borne de conexión
- F Apertura opcional para cableado de superficie

3.4



- G Detalle: potenciómetro regulación crepuscular

Visión general del equipo NightmatIQ Plus

3.5

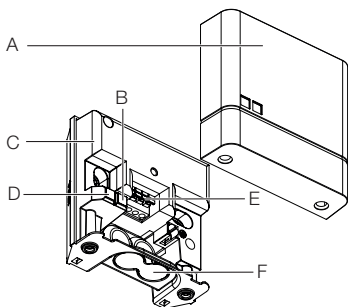

- A Cubierta
- B LED de estado
- C Carcasa interruptor crepuscular
- D Sensor de luminosidad
- E Borne de conexión
- F Apertura opcional para cableado de superficie

4. Conexión eléctrica

Diagrama electrónico

4.1

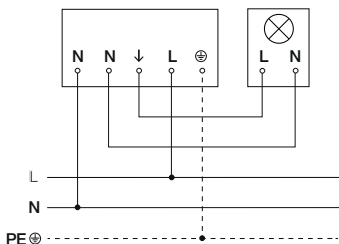

El cable de alimentación de red consta de un conductor trifilar:

- L** = fase (generalmente negro, marrón o gris)
- N** = neutro (generalmente azul)
- PE** = toma de tierra (verde/amarillo)

El aparato también puede conectarse eléctricamente después de un interruptor de red si se garantiza que el interruptor de red está permanentemente conectado.

Los tapones obturadores están previstos para un cable de alimentación con un diámetro exterior de 5 a 10 mm.

5. Montaje



¡Peligro por corriente eléctrica!

El contacto físico con piezas conductoras de electricidad puede causar shocks eléctricos, quemaduras o la muerte.

- Desconectar la corriente e interrumpir la alimentación de tensión.
- Controlar la ausencia de tensión con un comprobador de tensión.
- Asegurar que la alimentación de tensión permanezca interrumpida.

¡Peligro de daños materiales!

Los cables invertidos pueden causar cortocircuitos.

- Identificar los cables de conexión.
- Conectar correctamente los cables de conexión.

Preparación de montaje

- Asegurarse de que todos los componentes se encuentran en perfecto estado. No poner en servicio el aparato si presenta daños.
- Elegir un lugar de montaje adecuado.
 - Sin vibraciones.
 - No en zonas con peligro de explosión.
 - No sobre superficies fácilmente inflamables.
 - El dispositivo no debe verse afectado por la luz del consumidor conectado.

El montaje por pasos

5.1

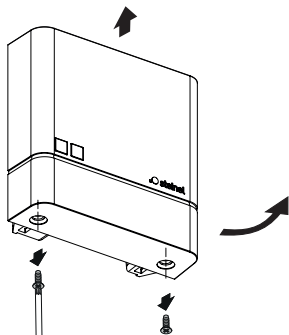

- Desconectar la alimentación eléctrica.
- Comprobar que la alimentación de tensión esté desconectada.
- Desatornillar y retirar la cubierta.

5.2

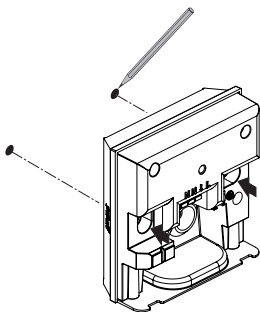

- Marcar los orificios a taladrar.

5.3

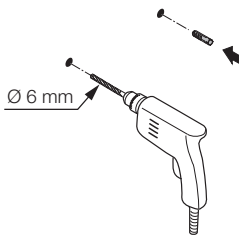

- Taladrar los orificios (\varnothing 6 mm) e insertar los tacos.

Variante empotrada

5.4

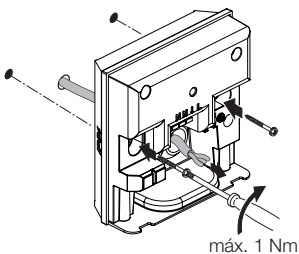

- Pasar el cable por el dispositivo.
- Atornillar el dispositivo con un par máximo de 1 Nm.

Variante de superficie

5.5

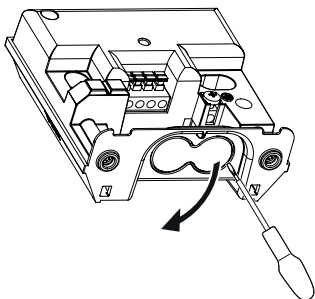

- Ábrase con cuidado la abertura opcional para el cableado de superficie con un destornillador.

5.6

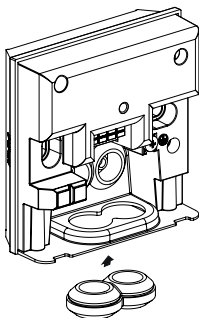

- Colocar el tapón obturador.

5.7

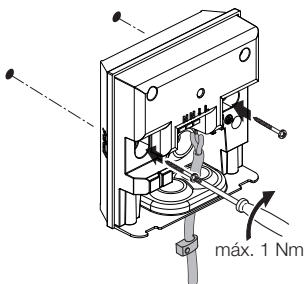

- Pasar el cable por el dispositivo.
- Atornillar el dispositivo con un par máximo de 1 Nm.

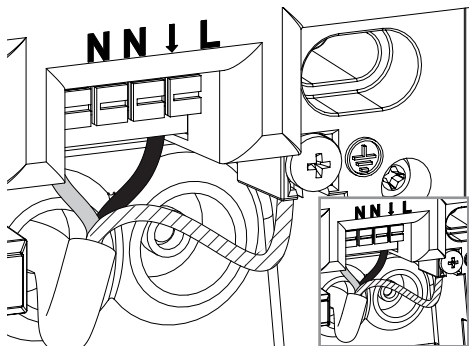

- Conectar el cable de alimentación conforme al diagrama electrónico.

→ „4. Conexión eléctrica“

5.9

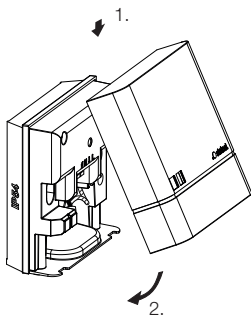

- Colocar la cubierta.

5.10

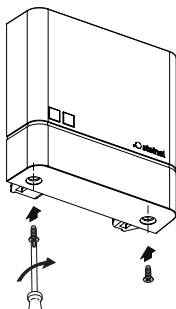

- Atornillar la cubierta.



- Conectar la alimentación eléctrica.
 - Ajustar las funciones.
- „6. Funciones“

6. Funciones

NightmatIQ

En el NightmatIQ, la regulación crepuscular se configura a mano vía potenciómetro.



¡Peligro por corriente eléctrica!

El contacto físico con piezas conductoras de electricidad puede causar shocks eléctricos, quemaduras o la muerte.

- Desconectar la corriente e interrumpir la alimentación de tensión.
- Controlar la ausencia de tensión con un comprobador de tensión.
- Asegurar que la alimentación de tensión permanezca interrumpida.

- **Configuración de fábrica**
 - Regulación crepuscular: 75 lux

Regulación crepuscular (G)

La luminosidad reactiva (crepúsculo) puede regularse sin etapas entre aprox. 1 y 75 lux.

- ☼ = funcionamiento crepuscular (aprox. 75 lux)
- ☾ = funcionamiento crepuscular/nocturno (aprox. 1 lux)

Regulación crepuscular manual NightmatIQ

6.1

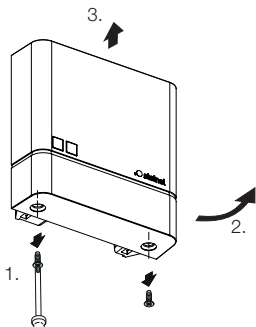

- Desconectar la alimentación eléctrica.
- Comprobar que la alimentación de tensión esté desconectada.
- Desatornillar la cubierta.

6.2

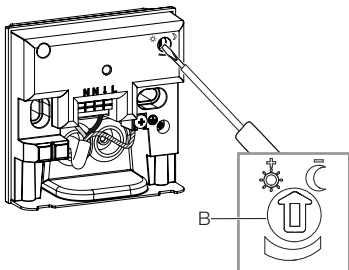

- Ajustar el umbral de respuesta de la regulación crepuscular sin etapas con el destornillador.

6.3

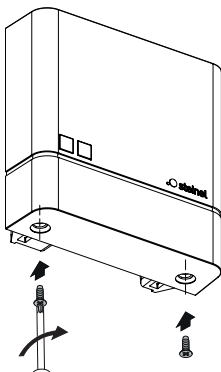

- Atornillar la cubierta.

6.4



- Conectar la alimentación eléctrica.

NightmatIQ Plus

En el NightmatIQ Plus, las funciones se configuran vía Steinel Connect App.

Steinel Connect App

Para configurar el dispositivo vía smartphone o tablet, se ha de bajar la aplicación STEINEL Connect de su AppStore. Se requiere un smartphone o tablet aptos para Bluetooth.



Android



iOS



Funciones ajustables vía la Steinel Connect App:

- Regulación crepuscular.

Nota:

Se deberá guardar una distancia mínima de 3 m al enrutador wifi y los puntos de acceso para excluir fallos.

Funciones LED

Inicialización: luz LED permanente.

Operación normal: LED apagado.

Identificación: LED parpadea despacio.

Actualización firmware: LED parpadea rápidamente.

Error: LED parpadea rápidamente.

Configuración de fábrica

- Regulación crepuscular: 1.000 lux

Regulación crepuscular

La luminosidad reactiva (crepúsculo) puede regularse sin etapas entre aprox. 1 y 1.000 lux.

- ☀ = funcionamiento crepuscular (aprox. 1.000 lux)
- ☾ = funcionamiento crepuscular/nocturno (aprox. 1 lux)

Interconexión vía Bluetooth (Bluetooth Mesh)

El sensor conmutador cumple con el estándar Bluetooth Mesh. Puede interconectarse con cualquier producto que cumpla el estándar Bluetooth Mesh.

El sensor conmutador se configura vía la app Steinel Connect. A establecerse la primera conexión entre el sensor conmutador y la app Steinel Connect, se memorizan las correspondientes claves de red en el smartphone o el tablet. A base de las claves, se excluye un acceso indebido al sensor.

Para el acceso a otro smartphone o tablet adicional, hay que compartir la clave de red.

Tiempos de conmutación

Además de establecer el valor crepuscular, la aplicación también se puede emplear para ajustar los tiempos de conmutación cuando los consumidores conectados se enciendan o apaguen.

El NightmatIQ Plus recibe la hora actual a través de la conexión Bluetooth con un smartphone/tablet y la utiliza para la futura conmutación.

Al interrumpirse la alimentación del NightmatIQ Plus, éste pierde la hora memorizada. Basado en el curso del sol de los días anteriores, el NightmatIQ Plus determina una hora aproximada. Para restablecer la hora exacta, se requiere una nueva conexión con la aplicación.

7. Limpieza y cuidados

El aparato está exento de mantenimiento.



¡Peligro por corriente eléctrica!

El contacto del agua con piezas conductoras de electricidad puede causar shocks eléctricos, quemaduras o la muerte.

- Limpiar el aparato solo en estado seco.

¡Peligro de daños materiales!

Utilizando un limpiador no apropiado, el aparato puede sufrir daños.

- Limpiar el aparato con un paño ligeramente humedecido sin detergente.

8. Eliminación

Los aparatos eléctricos, las baterías, los accesorios y los embalajes deben reciclarse de forma respetuosa con el medio ambiente.



¡No eche los aparatos eléctricos ni baterías a la basura doméstica!

Solo para países de la UE:

Según la Directiva europea vigente sobre residuos de aparatos eléctricos y electrónicos y su transposición al derecho nacional, los aparatos eléctricos y pilas fuera de uso deben recogerse por separado y someterse a un reciclaje respetuoso con el medio ambiente.

9. Garantía de fabricante

Este producto STEINEL ha sido elaborado con el máximo esmero, habiendo pasado los controles de funcionamiento y seguridad previstos por las disposiciones vigentes, así como un control adicional de muestreo al azar. Steinel garantiza el perfecto estado y funcionamiento. El período de garantía es de 36 meses comenzando el día de la venta al consumidor. Reparamos defectos de material o de fabricación, la garantía se aplicará a base de la reparación o el cambio de piezas defectuosas, según nuestro criterio. La prestación de garantía queda anulada para daños producidos en piezas de desgaste y daños y defectos originados por uso o mantenimiento inadecuados. Quedan excluidos de la garantía los daños consecuenciales causados en objetos ajenos.

La garantía solo será efectiva enviando el aparato no deshecho, con una breve descripción del fallo, tíquet de caja o factura (con fecha de compra y sello del comercio), bien empaquetado, al correspondiente centro de servicio.

Servicio de reparación:

Una vez transcurrido el período de garantía o en caso de defectos sin derecho de garantía, consulte su centro de servicio más próximo para averiguar una posible reparación.

3 AÑOS
DE GARANTÍA
DE FABRICANTE

10. Datos técnicos

- Dimensiones (alt. x anch. x prof.): 95 x 95 x 38 mm
- Tensión de red: 220-240 V, 50/60 Hz
- Consumo de potencia: *NightmatIQ* < 0,7 W
NightmatIQ plus < 0,5 W
- Regulación crepuscular: *NightmatIQ*: 1-75 lux
NightmatIQ Plus: 1-1.000 lux
- Sensor: fototransistor
- Rango de temperatura: -20 a +40 °C
- Frecuencia Bluetooth (solo *NightmatIQ Plus*): 2,4-2,48 GHz
- Potencia de emisión Bluetooth (solo *NightmatIQ Plus*): 4 dBm/2,5 mW
- Índice de protección: IP 54

Potencia de ruptura

- Carga de bombilla incandescente/halógena: 1.000 W
- Lámparas halógenas bajo voltaje: 1.000 VA
- Lámparas fluorescentes no compensadas: 500 VA
- Lámparas fluorescentes compensadas en serie: 500 VA
- Lámparas fluorescentes compensadas en paralelo: 500 VA
- Lámparas fluorescentes balastro electrónico: 250 W
- Lámparas LED < 2 W: 100 W
- Lámparas LED > 2 W <8 W: 125 W
- Lámparas LED >8 W: 250 W
- Carga capacitiva: 88 µF

11. Reparación de averías

Aparato sin tensión.

- Fusible desactivado o defectuoso.
 - Activar fusible.
 - Cambiar el fusible defectuoso.
- Línea interrumpida.
 - Comprobar la línea de alimentación con un comprobador de tensión.
- Cortocircuito en el cable de alimentación.
 - Comprobar las conexiones.
- El interruptor de alimentación está desconectado (si lo hay).
 - Poner el interruptor en ON.

El aparato no se enciende.

- Regulación crepuscular mal seleccionada.
 - Ajustar de nuevo la regulación crepuscular.
- El interruptor de alimentación está en OFF.
 - Ajustar el interruptor de alimentación.
- Fusible desactivado o defectuoso.
 - Activar fusible.
 - Cambiar el fusible defectuoso.

Índice

1.	Sobre este documento	3
2.	Instruções de segurança gerais	3
3.	Descrição do aparelho	4
4.	Ligação elétrica	9
5.	Montagem	10
6.	Funcionamento	19
7.	Limpeza e conservação	24
8.	Reciclagem	24
9.	Garantia do fabricante	25
10.	Dados técnicos	26
11.	Eliminação de avarias	27

1. Sobre este documento

- Protegido pela lei sobre direitos de autor. Qualquer reimpressão, mesmo que apenas parcial, só é permitida com o nosso consentimento.
- Reservado o direito a alterações que visem o progresso técnico.



Aviso de perigo!



Aviso de perigo originado por eletricidade!



Aviso de perigo originado por água!

2. Instruções de segurança gerais



A inobservância das instruções de utilização acarreta perigos!

Estas instruções contêm informações importantes para a utilização segura do aparelho. Potenciais perigos são identificados por indicações específicas. A inobservância destas indicações pode causar a morte ou ferimentos graves.

- Leia as instruções atentamente.
- Siga as instruções de segurança.
- Guarde as instruções num lugar acessível.
- Lidar com a corrente elétrica pode levar a situações perigosas. O contacto com peças condutoras de corrente pode resultar em choque elétrico, queimaduras ou na morte.
- Os trabalhos com tensão de rede só são permitidos se forem executados por pessoal profissional devidamente qualificado.
- É necessário respeitar as prescrições de instalação e condições de conexão em vigor nos diversos países (por ex., DE: VDE 0100, AT: ÖVE-ÖNORM E8001-1, CH: SEV 1000).

- Utilize somente peças de reposição originais.
- Reparações só são permitidas se forem realizadas por empresas especializadas.

3. Descrição do aparelho

Utilização prevista NighmatIQ

- Interruptor crepuscular, apropriado para montar na parede, tanto no interior como no exterior.
- Função de regulação crepuscular configurável através de potenciómetro.
- Utilizável como detetor individual.

Utilização prevista NighmatIQ Plus

- Interruptor crepuscular, apropriado para montar na parede, tanto no interior como no exterior.
- Funções configuráveis com a aplicação Steinel Connect.
- Utilizável como detetor individual ou para ligação em rede via Bluetooth.

Princípio de funcionamento

- O interruptor crepuscular deteta a luminosidade ambiente através do sensor de luz e compara-a com o limiar de luminosidade definido.
- Se a luminosidade ambiente estiver abaixo do limiar de luminosidade, o consumidor conectado liga-se.
- Se a luminosidade ambiente estiver acima do limiar de luminosidade, o consumidor conectado desliga-se.

Itens fornecidos NightmatIQ / NightmatIQ Plus

3.1

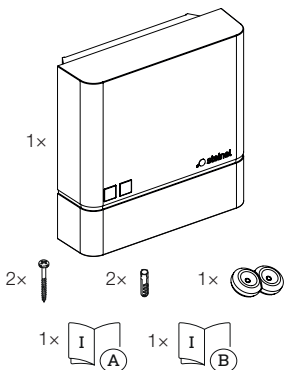

- 1 NightmatIQ / NightmatIQ Plus
- 2 parafusos
- 2 buchas
- 1 buçim vedante
- 1 ficha de dados de segurança
- 1 guia rápido

Dimensões do produto NightmatIQ / NightmatIQ Plus

3.2

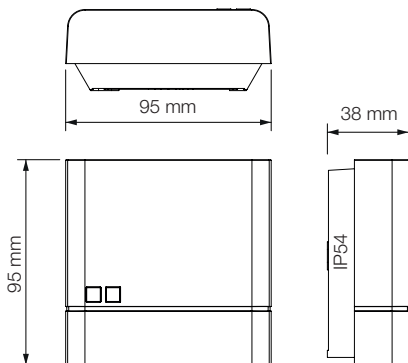

Vista geral do aparelho NightmatIQ

3.3

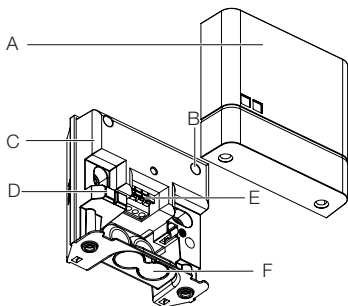

- A Cobertura
- B Potenciómetro da regulação crepuscular
- C Carcaça do interruptor crepuscular
- D Detetor de luminosidade
- E Barra de junção
- F Abertura opcional para montagem saliente da cablagem

3.4



- G Detalhe: potenciómetro da regulação crepuscular

Vista geral do aparelho NightmatIQ Plus

3.5

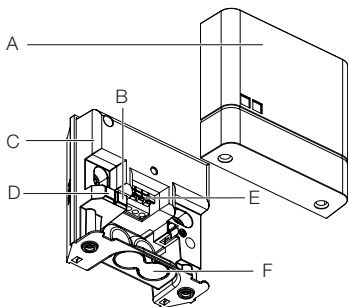

- A Cobertura
- B LED de estado
- C Carcaça do interruptor crepuscular
- D Detetor de luminosidade
- E Barra de junção
- F Abertura opcional para montagem saliente da cablagem

4. Ligação elétrica

Esquema de circuitos elétricos

4.1

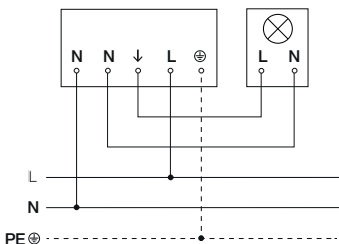

O cabo de alimentação elétrica é constituído por um cabo de 3 condutores:

- L** = fase (geralmente preto, castanho ou cinzento)
- N** = neutro (geralmente azul)
- PE** = condutor terra (verde/amarelo)

O aparelho também pode ser ligado a um interruptor de rede se ficar assegurado que o interruptor está sempre ligado.

Os buçins vedantes estão previstos para uma linha de alimentação com um diâmetro exterior de 5-10 mm.

5. Montagem



Perigo de eletrocussão!

O contacto com peças condutoras de corrente pode resultar em choque elétrico, queimaduras ou na morte.

- Desligue a corrente e suspenda a alimentação de tensão.
- Verifique a ausência de tensão com um busca-polos.
- Assegure-se de que a alimentação de tensão permanece interrompida.

Perigo de danos materiais!

Se os cabos de ligação forem trocados, poderá ocorrer um curto-circuito.

- Identifique os cabos de ligação.
- Ligue os cabos de ligação corretamente.

Preparação da montagem

- Verifique todos os componentes para detetar eventuais danos. Se detetar qualquer dano, não coloque o aparelho em funcionamento.
- Procure um local de montagem adequado.
 - À prova de trepidações.
 - Não em áreas potencialmente explosivas.
 - Não em cima de superfícies facilmente inflamáveis.
 - O aparelho não pode ser influenciado pela luz do ponto de consumo conectado.

Passos para montagem

5.1

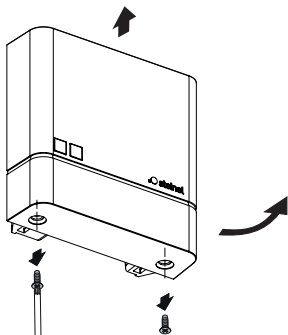

- Desligue a fonte de alimentação elétrica.
- Certifique-se de que a alimentação de tensão está desligada.
- Desaparafuse a cobertura e remova-a.

5.2

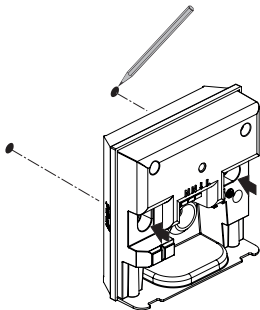

- Marque os furos.

5.3

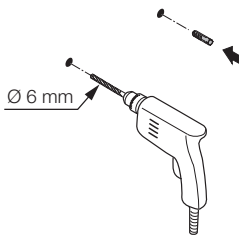

- Faça os furos (\varnothing 6 mm) e coloque as buchas.

Versão para montagem embutida

5.4

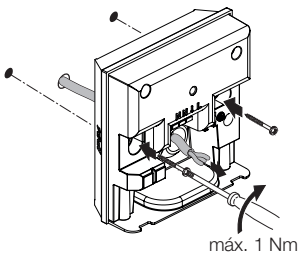

- Passe o cabo pelo aparelho.
- Aparafuse o aparelho com um binário de aperto máx. 1 Nm.

Versão para montagem à superfície

5.5

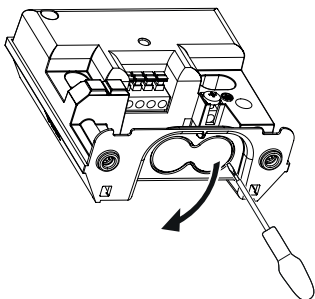

- Use uma chave de fendas para partir com cuidado a abertura opcional para montagem saliente da cablagem.

5.6

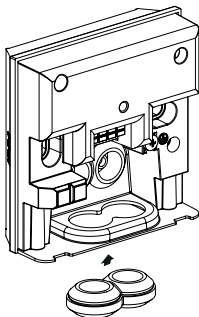

- Coloque o bucim vedante.

5.7

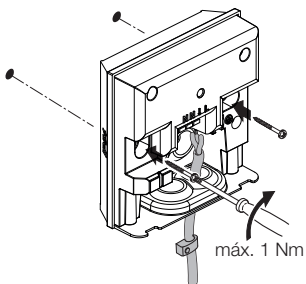

- Passe o cabo pelo aparelho.
- Aparafuse o aparelho com um binário de aperto máx. 1 Nm.

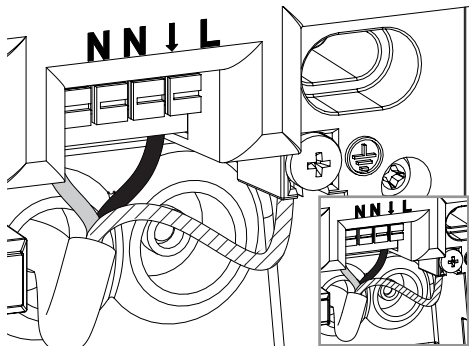

- Faça a ligação à rede segundo o esquema elétrico.
→ „4. Ligação elétrica“

5.9

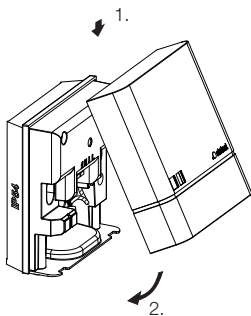

- Coloque a cobertura.

5.10

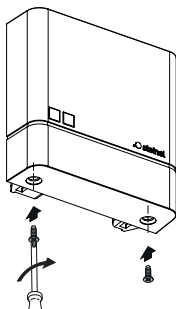

- Aparafuse a tampa.



- Ligue a fonte de alimentação elétrica.
 - Ajuste as funções.
- „6. Funcionamento“

6. Funcionamento

NightmatIQ

No caso do sistema NightmatIQ, a regulação crepuscular é realizada manualmente com o potenciômetro de regulação crepuscular.



Perigo de eletrocussão!

O contacto com peças condutoras de corrente pode resultar em choque elétrico, queimaduras ou na morte.

- Desligue a corrente e suspenda a alimentação de tensão.
- Verifique a ausência de tensão com um busca-polos.
- Assegure-se de que a alimentação de tensão permanece interrompida.
- **Configurações de fábrica**
 - Regulação crepuscular: 75 lux

Regulação crepuscular (G)

A luminosidade de resposta (crepúsculo) pode ser ajustada progressivamente de aprox. 1 a 75 lux.

- ☀ = modo crepuscular (aprox. 75 lux)
- ☾ = modo crepuscular/modo noturno (aprox. 1 lux)

Regulação crepuscular manual NightmatIQ

6.1

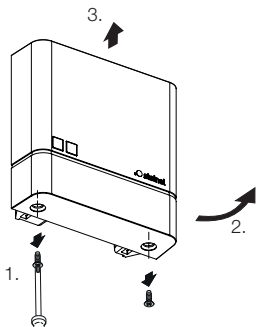

- Desligue a fonte de alimentação elétrica.
- Certifique-se de que a alimentação de tensão está desligada.
- Desaparafuse a tampa.

6.2

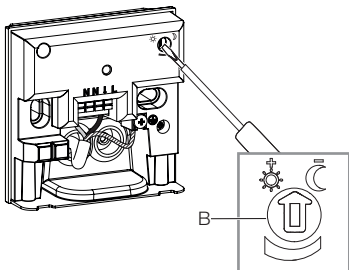

- Regulação progressiva do limiar de luminosidade com uma chave de fendas.

6.3

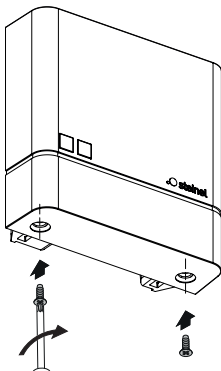

- Aparafuse a tampa.

6.4



- Ligue a fonte de alimentação elétrica.

NightmatIQ Plus

No caso do sistema NightmatIQ Plus, a configuração das funções é efetuada com a aplicação Steinel Connect.

Aplicação Steinel Connect

Para configurar o aparelho com um smartphone ou um tablet, tem de descarregar a aplicação STEINEL Connect da sua AppStore. É necessário ter um smartphone ou tablet compatível com Bluetooth.



Android



iOS



Funções configuráveis com a aplicação Steinel Connect
– Regulação crepuscular.

Nota:

Tem de ser respeitada uma distância mínima de 3 m entre o router WiFi e os Access Points para evitar falhas de funcionamento.

Funcionamento dos LEDs

Inicialização: LED ligado.

Modo de funcionamento normal: LED desligado.

Identificação: LED pisca lentamente.

Atualização firmware: LED pisca rapidamente.

Erro: LED pisca rapidamente.

Configurações de fábrica

- Regulação crepuscular: 1000 lux

Regulação crepuscular

A luminosidade de resposta (crepúsculo) pode ser ajustada progressivamente de aprox. 1 a 1000 lux.

- ☀ = modo crepuscular (aprox. 1000 lux)
- ☾ = modo crepuscular/modo noturno (aprox. 1 lux)

Ligação em rede via Bluetooth (Bluetooth Mesh)

O interruptor com detetor é compatível com o padrão Bluetooth Mesh. Pode ser ligado em rede com todos os produtos compatíveis com o padrão Bluetooth Mesh.

A configuração do interruptor com detetor é realizada através da aplicação Steinel Connect. Ao ser estabelecida a primeira ligação entre o interruptor com detetor e a aplicação Steinel Connect, as respetivas chaves de rede são guardadas no smartphone ou no tablet. As chaves impedem o acesso não-autorizado ao detetor.

Para poder aceder através de outro smartphone ou tablet, será necessário partilhar a chave de rede.

Horas de comutação

Além da regulação do valor crepuscular, a aplicação também permite definir as horas de comutação às quais os pontos de consumo conectados devem ligar-se e desligar-se.

O sistema NightmatIQ plus pode ser ligado via Bluetooth a um smartphone/tablet e recebe, assim, a hora atual para a usar para a comutação futura.

Ao interromper a alimentação de corrente do NightmatIQ plus, ele perde a hora memorizada. Com base no curso do Sol do dia anterior, o NightmatIQ plus faz uma estimativa da hora. Para restabelecer a hora exata, o sistema tem de ser ligado à aplicação.

7. Limpeza e conservação

O aparelho não requer qualquer tipo de manutenção.



Perigo de eletrocussão!

O contacto de água com peças condutoras de corrente pode resultar em choque elétrico, queimaduras ou na morte.

- Limpe o aparelho apenas se estiver seco.

Perigo de danos materiais!

A utilização dos detergentes errados pode danificar o aparelho.

- Limpe o aparelho com um pano ligeiramente humedecido sem detergente.

8. Reciclagem

Equipamentos elétricos, pilhas, acessórios e embalagens têm de ser entregues num posto de revalorização ecológica.



Nunca deite equipamentos elétricos ou pilhas para o lixo doméstico!

Apenas para estados membros da U.E.:

Segundo a diretiva europeia relativa aos resíduos de equipamentos elétricos e eletrónicos, e a respetiva transposição para o direito nacional, todos os equipamentos elétricos e eletrónicos e pilhas em fim de vida útil devem ser recolhidos separadamente e entregues nos pontos de recolha previstos para fins de revalorização ecológica.

9. Garantia do fabricante

Este produto Steinel foi fabricado com todo o zelo e o seu funcionamento e segurança verificados, de acordo com as normas em vigor, e sujeito a um controlo por amostragem aleatória. A STEINEL garante o bom estado e o bom funcionamento do aparelho. O prazo de garantia é de 36 meses a contar da data de compra. Damos garantia a falhas relacionadas com defeitos de material ou de fabrico. A garantia inclui a reparação ou a substituição das peças com defeito, de acordo com o nosso critério, estando excluídas as peças sujeitas a desgaste, os danos e as falhas originados por uma utilização ou manutenção incorreta. Excluem-se igualmente os danos provocados noutros objetos estranhos ao aparelho.

Os serviços previstos na garantia só serão prestados caso o aparelho seja apresentado bem embalado no respetivo serviço de assistência técnica, devidamente montado e acompanhado do talão da caixa ou da fatura (data da compra e carimbo do revendedor) e de uma pequena descrição do problema.

Serviço de reparação: depois de expirado o prazo de garantia ou em caso de falha não abrangida pela garantia, contacte o serviço de assistência técnica mais perto de si para saber quais são as possibilidades de reparação.

3 ANOS
GARANTIA
DO FABRICANTE

10. Dados técnicos

- Dimensões (A × L × P): 95 × 95 × 38 mm
- Ligação à rede: 220-240 V, 50/60 Hz
- Potência absorvida: *NightmatIQ* < 0,7 W
NightmatIQ plus < 0,5 W
- Regulação crepuscular: *NightmatIQ*: 1-75 lux
NightmatIQ plus: 1-1000 lux
- Sistema de sensores: fototransistor
- Intervalo de temperaturas: -20 até +40 °C
- Frequência Bluetooth (só *NightmatIQ plus*): 2,4-2,48 GHz
- Potência emissora Bluetooth (só *NightmatIQ plus*): 4 dBm/2,5 mW
- Grau de proteção: IP 54

Potência de comutação

- Carga de lâmpada incandescente/halogéneo: 1000 W
- Lâmpadas de halogéneo de baixa tensão: 1000 VA
- Lâmpadas fluorescentes, descompensado: 500 VA
- Lâmpadas fluorescentes, compensado em série: 500 VA
- Lâmpadas fluorescentes, compensado em paralelo: 500 VA
- Lâmpadas fluorescentes, balastro eletrônico: 250 W
- Lâmpadas LED <2 W: 100 W
- Lâmpadas LED >2 W <8 W: 125 W
- Lâmpadas LED >8 W: 250 W
- Carga capacitiva: 88 µF

11. Eliminação de avarias

Aparelho sem tensão.

- O fusível não está ligado ou está com defeito.
 - Ligue o fusível.
 - Substitua o fusível defeituoso.
- Linha interrompida.
 - Verifique a linha com um busca-polos.
- Curto-circuito no cabo de alimentação elétrica.
 - Verificar as ligações.
- Interruptor de rede eventualmente existente está desligado.
 - Ligue o interruptor de rede.

O aparelho não se liga.

- Foi escolhida a regulação crepuscular errada.
 - Reajuste a regulação crepuscular.
- Interruptor de rede DESLIGADO.
 - Ligue o interruptor de rede.
- O fusível não está ligado ou está com defeito.
 - Ligue o fusível.
 - Substitua o fusível defeituoso.

Innehåll

1.	Om detta dokument	3
2.	Allmänna säkerhetsanvisningar	3
3.	Produktbeskrivning	4
4.	Elektrisk anslutning	9
5.	Montage	10
6.	Funktion	19
7.	Rengöring och skötsel	24
8.	Avfallshantering	24
9.	Tillverkargaranti	25
10.	Tekniska data	26
11.	Åtgärdande av störningar	27

1. Om detta dokument

- Upphovsrättsligt skyddat. Eftertryck, även delar av texten, bara med vårt samtycke.
- Ändringar som görs pga den tekniska utvecklingen, förbehålles.



Varning för fara!



Varning för fara genom elektrisk ström!



Varning för fara genom vatten!

2. Allmänna säkerhetsanvisningar



Fara om bruksanvisningen inte följs!

Bruksanvisningen innehåller viktig information för en säker hantering av armaturen. Särskild uppmärksamhet riktas mot eventuella faror. Om bruksanvisningen inte följs kan det leda till dödsfall eller allvarliga personskador.

- Läs bruksanvisningen noggrant.
- Följ säkerhetsanvisningarna.
- Förvara den tillgängligt.
- Hantering av elektrisk ström kan leda till farliga situationer. Kontakt med strömförande delar kan medföra elektrisk chock, brännsår eller leda till döden.
- Arbeten på nätspänningen får endast genomföras av kvalificerad yrkespersonal.
- Installationsföreskrifter och anslutningskrav som gäller i respektive land ska iakttas (t.ex. DE: VDE 0100, AT: ÖVE-ÖNORM E8001-1, CH: SEV 1000).
- Använd endast originalreservdelar.
- Reparationer får endast genomföras av professionella företag.

3. Produktbeskrivning

Ändamålsenlig användning NighmatIQ

- Skymningsbrytare, avsedd för väggmontage inomhus och utomhus.
- Funktion skymningsinställning ställs in via potentiometern.
- Kan användas som enskild sensor.

Ändamålsenlig användning NighmatIQ Plus

- Skymningsbrytare, avsedd för väggmontage inomhus och utomhus.
- Funktioner som kan ställas in via Steinell Connect appen.
- Kan användas som enskild sensor eller sammankopplad med Bluetooth.

Funktionsprincip

- Skymningsbrytaren uppfattar omgivningsljuset med hjälp av ljussensorerna och jämför det med det inställda ljusnivåvärdet.
- Ligger omgivningsljuset under ljusnivåvärdet, tänds den anslutna förbrukaren.
- Ligger omgivningsljuset över ljusnivåvärdet, släcks den anslutna förbrukaren.

Innehåll NightmatIQ / NightmatIQ Plus

3.1

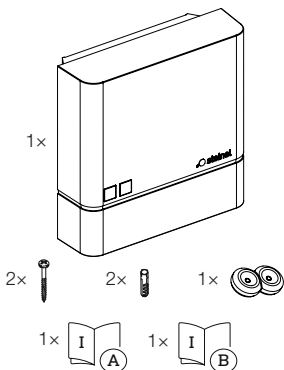

- 1 NightmatIQ / NightmatIQ Plus
- 2 skruvar
- 2 pluggar
- 1 packning
- 1 säkerhetsdatablad
- 1 quick-start

Produktmått NightmatIQ / NightmatIQ Plus

3.2

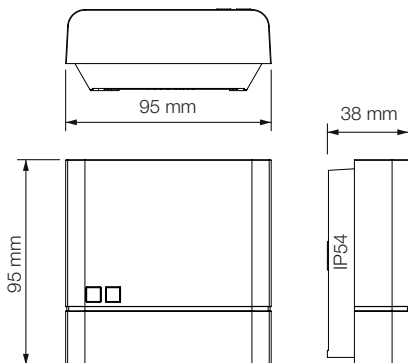

Översikt över enhet NightmatIQ

3.3

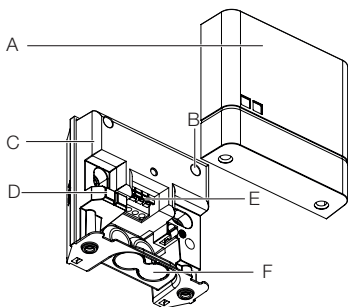

- A Skydd
- B Poti skymningsinställning
- C Hus skymningsrelä
- D Ljusstyrkesensor
- E Anslutningsplint
- F Valfri öppning för utanpåliggande kabel

3.4



- G Detalj: Poti skymningsinställning

Översikt över enhet NightmatIQ Plus

3.5

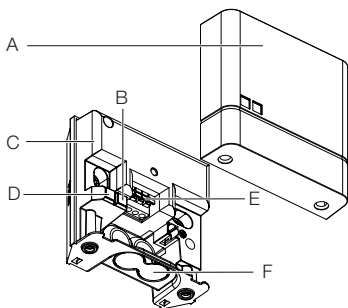

- A Skydd
- B Status LED
- C Hus skymningsrelä
- D Ljusstyrkesensor
- E Anslutningsplint
- F Valfri öppning för utanpåliggande kabel

4. Elektrisk anslutning

Kopplingschema

4.1

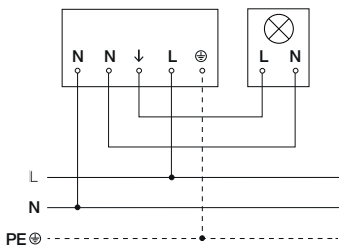

Nätledningen består av en 3-ledarkabel:

- L** = Fas (oftast svart, brun eller grå)
- N** = Neutralledare (oftast blå)
- PE** = Skyddsledare (grön/gul)

Armaturen kan även anslutas elektriskt efter en nätbrytare, om det är säkert, att nätbrytaren är ständigt tillkopplad.

Tätningssluggarna är avsedda för en nätanslutning med en ytterdiameter på 5-10 mm.

5. Montage



Fara p.g.a. elektrisk ström!

Kontakt med strömförande delar kan medföra elektrisk chock, brännsår eller döden.

- Slå ifrån strömmen och avbryt spänningsförsörjningen.
- Kontrollera med spänningsprovare att alla ledningar är spänningsfria.
- Se till att spänningen inte kan slås till igen.

Risk för materiella skador!

En förväxling av anslutningarna kan leda till kortslutning.

- Identifiera anslutningsledningarna.
- Sammankoppla anslutningsledningarna korrekt.

Montageförberedelser

- Kontrollera samtliga delar med avseende på skador. Är armaturen skadad får den inte tas i bruk.
- Välj en lämplig monteringsplats.
 - Vibrationsfritt.
 - Inte i explosionsfarliga miljöer.
 - Inte på lättantändliga underlag.
 - Armaturen får inte påverkas av ljuset från den anslutna förbrukaren.

Montageordning

5.1

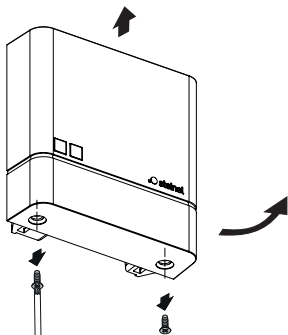

- Stäng av strömförsörjningen.
- Kontrollera att spänningen är frånslagen.
- Skruva av skyddet och dra av det.

5.2

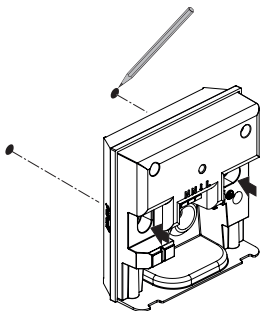

- Markera borrhålen.

5.3

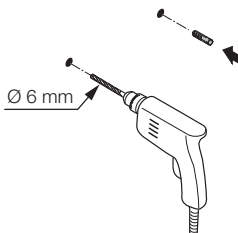

- Borra hål (ø 6 mm) och sätt i pluggar.

Variant infällt montage

5.4

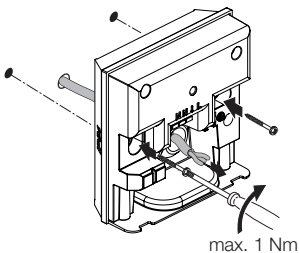

- Dra kabeln genom armaturen.
- Skruva fast armaturen med ett vridmoment på max. 1 Nm.

Utanpåliggande variant

5.5

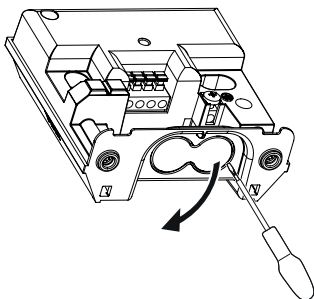

- Bryt försiktigt ut den valfria öppningen för den utanpåliggande kabeln med en skruvmejsel.

5.6



- Sätt i tätningsplugg.

5.7

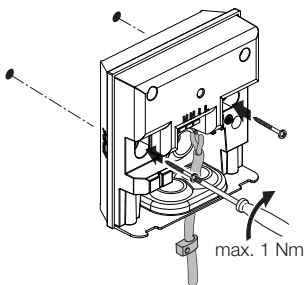

- Dra kabeln genom armaturen.
- Skruva fast armaturen med ett vridmoment på max. 1 Nm.

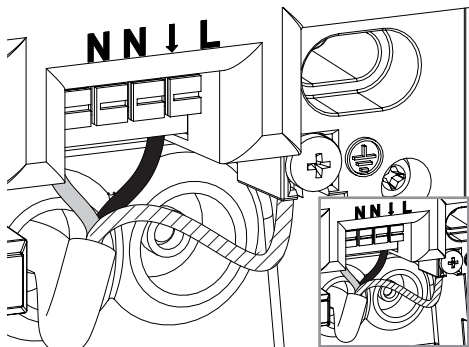

- Anslut nätkabeln enligt kopplingschemat.
→ „4. Elektrisk anslutning“

5.9

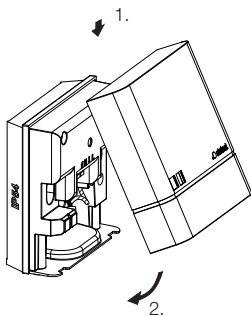

- Sätt på skyddet.

5.10

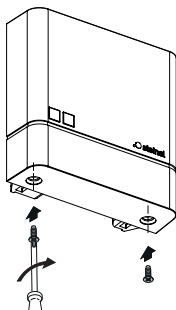

- Skruva på skyddet.



- Slå till spänningen.
 - Ställ in funktionerna.
- „6. Funktion“

6. Funktion

NightmatIQ

På NightmatIQ görs skymningsinställningen manuellt via skymningsinställningen Poti.



Fara p.g.a. elektrisk ström!

Kontakt med strömförande delar kan medföra elektrisk chock, brännsår eller döden.

- Slå ifrån strömmen och avbryt spänningsförsörjningen.
- Kontrollera med spänningsprovare att alla ledningar är spänningsfria.
- Se till att spänningen inte kan slås till igen.

- **Fabriksinställningar**

- Skymningsinställning: 75 lux

Skymningsinställning (G)

Reaktionsnivån (skymning) kan ställas in steglöst från ca 1-75 lux

- ☀ = Skymningsdrift (ca 75 lux)
- ☾ = Skymningsdrift/nattdrift (ca 1 lux)

Manuell skymningsinställning NightmatIQ

6.1

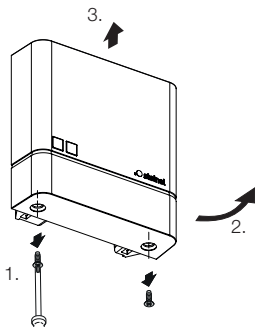

- Stäng av strömförsörjningen.
- Kontrollera att spänningen är frånslagen.
- Skruva av skyddet.

6.2

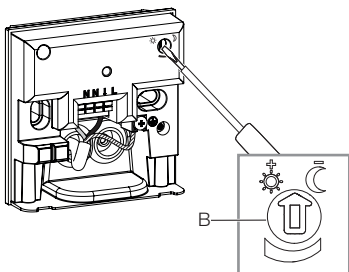

- Ställ in önskad aktiveringsnivå för skymningsinställningen steglöst med skruvmejseln.

6.3

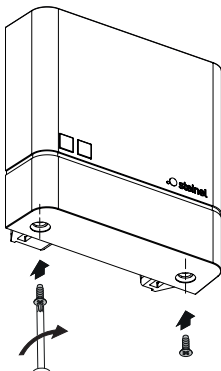

- Skruva på skyddet.

6.4



- Slå till spänningen.

NightmatIQ Plus

På NightmatIQ sker inställningen av funktionerna via Steinel Connect appen.

Steinel Connect app

För att konfigurera apparaten med smarttelefon eller surfplatta måste STEINEL Connect appen laddas ner från din AppStore. Det krävs en Bluetooth-förberedd smarttelefon eller surfplatta.



Android



iOS



Funktioner som kan ställas in med Steinel Connect appen:

- Skymningsinställning.

Anmärkning:

Minst 3 m avstånd måste hållas till WLAN-routern och till Access Points, för att kunna utesluta felfunktioner.

LED-funktion

Initialisering: LED lyser permanent.

Normaldrift: LED uteblir.

Identifiering: LED blinkar långsamt.

Firmware Update: LED blinkar snabbt.

Fel: LED blinkar snabbt.

Fabriksinställningar

- Skymningsinställning: 1 000 lux

Skymningsinställning

Reaktionsnivån (skymning) kan ställas in steglöst från ca 1-1 000 lux

- ☀ = Skymningsdrift (ca 1 000 lux)
- ☾ = Skymningsdrift/nattdrift (ca 1 lux)

Bluetooth sammankoppling (Bluetooth Mesh)

Sensorbrytaren motsvarar Bluetooth Mesh standard. Den kan sammankopplas med alla produkter som motsvarar Bluetooth Mesh standarden.

Sensorbrytarens konfigurerings sker per Steinel Connect app. Vid den första förbindelsen mellan sensorbrytaren och Steinel Connect appen sparas motsvarande nätverksnyckel på smarttelefonen eller surfplattan. Genom nyckeln är obehörig åtkomst till sensorn utesluten.

För åtkomsten via ännu en smarttelefon eller surfplatta måste nätverksnyckeln delas.

Kopplingstider

Förutom inställningen till skymningsvärdet kan även kopplingstider ställas in via appen, där anslutna förbrukare sätts PÅ resp stängs AV.

Genom Bluetooth-förbindelsen får NightmatIQ plus med en smartphone/surfplatta den aktuella tiden och använder denna för den senare kopplingen.

Bryts spänningstillförseln till NightmatIQ plus, går den inställda tiden förlorad. Baserande på solens förlopp de föregående dagarna tar NightmatIQ plus fram en ungefärlig tid. För att återställa den exakta tiden krävs på nytt en förbindelse med appen.

7. Rengöring och skötsel

Apparaten är underhållsfri.



Fara pga elektrisk ström!

Om vatten kommer i kontakt med strömförande delar kan det medföra elektrisk chock, brännsår eller dödsfall.

- Rengör bara apparaten när den är torr.

Risk för materiella skador!

Felaktiga rengöringsmedel kan orsaka skador på apparaten.

- Rengör den med en lätt fuktad trasa utan rengöringsmedel.

8. Avfallshantering

Elapparater, batterier, tillbehör och förpackning måste lämnas in till miljövänlig återvinning.



**Kasta inte elapparater och batterier
i hushållssoporna!**

Gäller endast EU-länder:

Enligt det gällande europeiska direktivet om uttjänta elektriska och elektroniska apparater och dess omsättning i nationell lagstiftning, måste uttjänta elapparater och batterier lämnas in till miljövänlig återvinning.

9. Tillverkargaranti

Denna Steinel-produkt är tillverkad med största noggrannhet. Den är funktions- och säkerhetstestad enligt gällande föreskrifter och har därefter genomgått en stickprovskontroll. Steinel garanterar felfritt tillstånd och felfri funktion. Garantin gäller i 36 månader från inköpsdagen. Vi åtgärdar bristfälligheter orsakade av material- eller tillverkningsfel. Garantin uppfylls genom reparation eller utbyte av bristfälliga delar efter vårt val. Garantin omfattar inte slitage och skador orsakade av felaktigt hanterande eller bristande underhåll och skötsel av produkten. Följdsador på främmande föremål ersätts ej.

Garantin gäller endast då produkten, som inte får vara demonterad, sändes väl förpackad med kort beskrivning av felet och fakturakopia eller kvitto (inköpsdatum och stämpel) till vår representant eller lämnas till inköpsstället.

Reparationservice:

Kontakta nästa serviceställe för reparationer efter garanti-tidens utgång eller vid bristfälligheter som inte omfattas av garantin.

3 Å R S
TILLVERKAR
GARANTI

10. Tekniska data

- Mått (H x B x D): 95 x 95 x 38 mm
- Spänning: 220-240 V, 50/60 Hz
- Energiförbrukning: *NightmatIQ* < 0,7 W
NightmatIQ plus < 0,5 W
- Skymningsinställning: *NightmatIQ*: 1-75 lux
NightmatIQ plus: 1-1 000 lux
- Sensorik: Fototransistor
- Temperaturområde: -20 till +40 °C
- Frekvens Bluetooth (endast *NightmatIQ plus*): 2,4-2,48 GHz
- Sändeffekt Bluetooth (endast *NightmatIQ plus*): 4 dBm/2,5 mW
- Skyddsklass: IP 54

Belastning

- Glöd-/halogenlamplast: 1 000 W
- Lågvolt halogenlampor: 1 000 VA
- Lysrör okompenserade: 500 VA
- Lysrör seriekompenserade: 500 VA
- Lysrör parallellkompenserade: 500 VA
- Lysrör elektroniskt förkopplingsdon: 250 W
- LED lampor <2W: 100 W
- LED lampor >2W <8W: 125 W
- LED lampor <8W: 250 W
- Kapacitiv belastning: 88 µF

11. Åtgärdande av störningar

Apparaten utan spänning

- Säkring inte påslagen eller defekt.
 - Tillkoppla säkringen.
 - Byt ut den defekta säkringen.
- Avbrott i kabel.
 - Kontrollera kabeln med spänningsprovare.
- Kortslutning i nätanslutningen.
 - Kontrollera anslutningarna.
- Eventuellt befintlig nätströmbrytare FRÅN
 - Slå till strömbrytaren.

Armaturen tänds inte.

- Felaktig skymningsinställning.
 - Ställ in skymningsinställningen på nytt.
- Nätströmbrytare FRÅN.
 - Ställ in nätströmbrytaren.
- Säkring inte påslagen eller defekt.
 - Tillkoppla säkringen.
 - Byt ut den defekta säkringen.

Indhold

1.	Om dette dokument	3
2.	Generelle sikkerhedsanvisninger	3
3.	Beskrivelse	4
4.	Elektrisk tilslutning	9
5.	Montering	10
6.	Funktion	19
7.	Rengøring og vedligeholdelse	24
8.	Bortskaffelse	24
9.	Producentgaranti	25
10.	Tekniske data	26
11.	Afhjælpning af fejl	27

1. Om dette dokument

- Ophavsretligt beskyttet. Eftertryk, også i uddrag, kun med vores tilladelse.
- Vi forbeholder os ret til ændringer af hensyn til den tekniske udvikling.



Advarsel mod farer!



Advarsel mod farer på grund af strøm!



Advarsel mod farer på grund af vand!

2. Generelle sikkerhedsanvisninger



Fare, hvis brugsanvisningen ikke følges!

Denne brugsanvisning indeholder vigtige informationer om sikker håndtering af enheden. Der gøres specifikt opmærksom på mulige farer. Manglende overholdelse kan medføre døden eller alvorlige kvæstelser.

- Læs brugsanvisningen omhyggeligt.
- Følg sikkerhedsanvisningerne.
- Opbevar brugsanvisningen, så der er adgang til den.
- Håndtering af elektrisk strøm kan medføre farlige situationer. Berøring af strømførende dele kan give elektrisk stød, forbrændinger og medføre dødsfald.
- Arbejde på netspænding må kun udføres af kvalificeret fagpersonale.
- Overhold det pågældende lands installationsforskrifter og tilslutningsregler (f. eks. DE: VDE 0100, AT: ÖVE-ÖNORM E8001-1, CH: SEV 1000).
- Brug kun originale reservedele.
- Reparationer må kun udføres af specialvirksomheder.

3. Beskrivelse

Korrekt anvendelse NighmatIQ

- Skumringskontakt, velegnet til indendørs og udendørs vægmontering.
- Skumringsindstillingens funktion kan indstilles med potentiometer.
- Kan anvendes som enkeltsensor.

Korrekt anvendelse NighmatIQ Plus

- Skumringskontakt, velegnet til indendørs og udendørs vægmontering.
- Funktionerne kan indstilles via Steinel Connect-appen.
- Kan anvendes som enkeltsensor eller i netværk med Bluetooth.

Funktionsprincip

- Skumringskontakten registrerer den omgivende lysstyrke ved hjælp af lyssensoren og sammenligner den med den indstillede tærskelværdi for lysstyrken.
- Hvis den omgivende lysstyrke ligger under tærskelværdien for lysstyrken, tændes den tilsluttede forbruger.
- Hvis den omgivende lysstyrke ligger over tærskelværdien for lysstyrken, slukkes den tilsluttede forbruger.

Leveringsomfang for NightmatIQ / NightmatIQ Plus

3.1

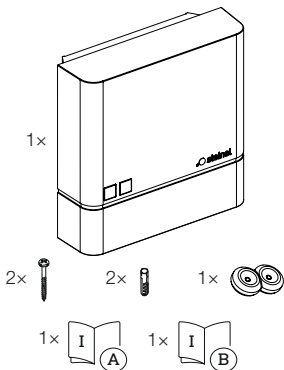

- 1 NightmatIQ / NightmatIQ Plus
- 2 skruer
- 2 rawplugs
- 1 lukkeprop
- 1 sikkerhedsdatablad
- 1 Quick-Start

Produktmål for NightmatIQ / NightmatIQ Plus

3.2

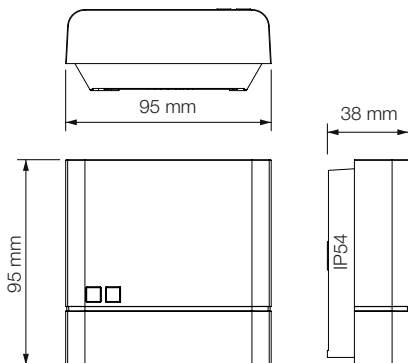

Oversigt over enheden NightmatIQ

3.3

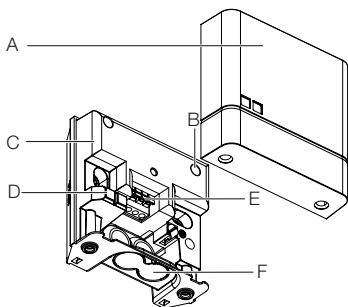

- A Kappe
- B Potentiometer til skumringsindstilling
- C Hus til skumringskontakt
- D Lysstyrkesensor
- E Tilslutningsklemme
- F Mulig åbning til ledningsføring på væg

3.4



- G Detalje: potentiometer til skumringsindstilling

Oversigt over enheden NightmatIQ Plus

3.5

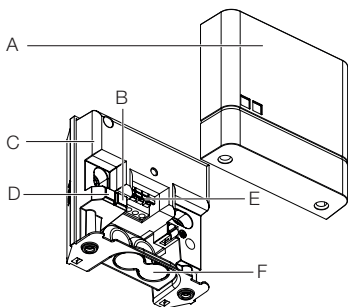

- A Kappe
- B Status-LED
- C Hus til skumringskontakt
- D Lysstyrkesensor
- E Tilslutningsklemme
- F Mulig åbning til ledningsføring på væg

4. Elektrisk tilslutning

Ledningsdiagram

4.1

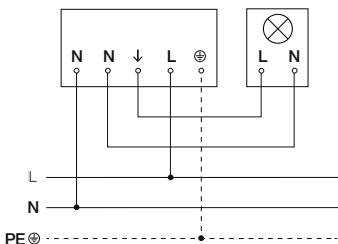

Nettilførslen består af en ledning med 3 ledere:

L = fase (oftest sort, brun eller grå)

N = nulleder (oftest blå)

PE = beskyttelsesleder (grøn/gul)

Enheden kan også tilsluttes elektrisk efter en netafbryder, hvis det er sikret, at netafbryderen altid er tændt.

Tætningspropperne er beregnet til en netledning med en udvendig diameter på 5-10 mm.

5. Montering



Fare pga. elektrisk strøm!

Berøring af strømførende dele kan give elektrisk stød, forbrændinger eller medføre dødsfald.

- Slå strømmen fra, og afbryd spændingstilførslen.
- Kontrollér med en spændingstester, om spændingen er afbrudt.
- Sørg for, at spændingstilførslen forbliver afbrudt.

Fare for materielle skader!

Ombytning af tilslutningsledningerne kan medføre kortslutning.

- Identificer tilslutningsledningerne.
- Forbind tilslutningsledningerne korrekt.

Forberedelse af montering

- Kontrollér alle komponenter for beskadigelser.
Er enheden beskadiget, må den ikke tages i brug.
- Vælg et egnet monteringssted.
 - Vibrationsfrit.
 - Ikke i eksplosionsfarlige områder.
 - Ikke på let brændbare overflader.
 - Enheden må ikke påvirkes af lyset fra den tilsluttede forbruger.

Monteringstrin

5.1

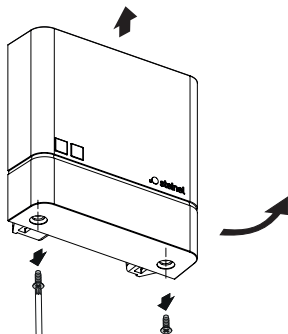

- Afbryd strømforsyningen
- Kontrollér, at spændingstilførslen er afbrudt
- Skru kappen af, og træk den af

5.2

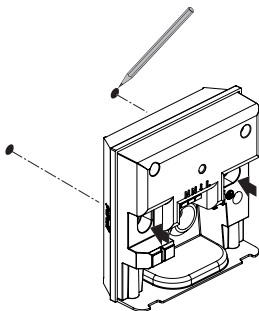

- Markér borehullerne

5.3

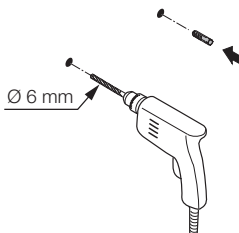

- Bor huller (ø 6 mm), og sæt rawlplugs i.

Variant med skjult ledningsføring

5.4

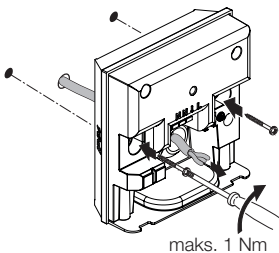

- Før ledningen gennem enheden.
- Skru enheden på med et drejningsmoment på maks. 1 Nm.

Variant med synlig ledningsføring

5.5

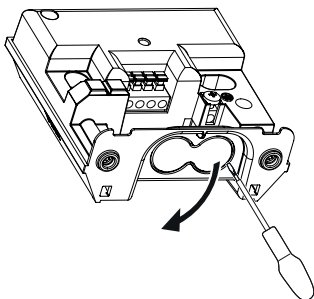

- Bryd forsigtigt den mulige åbning til ledningsføring på væggen ud med en skruetrækker.

5.6

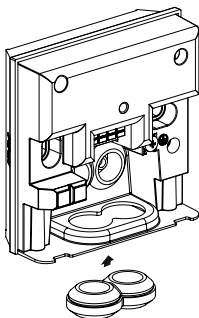

- Sæt tætningspropper i

5.7

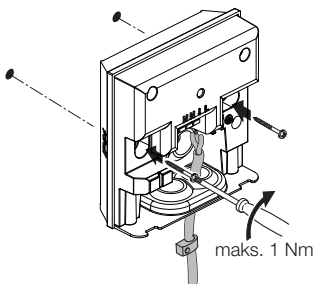

- Før ledningen gennem enheden.
- Skru enheden på med et drejningsmoment på maks. 1 Nm.

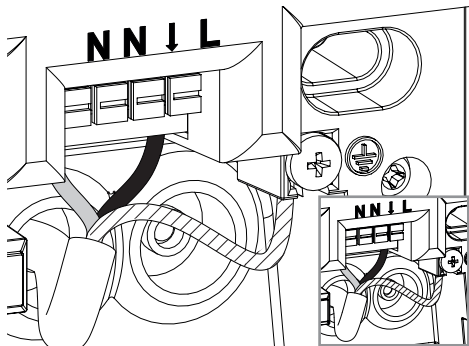

- Tilslut nettilførslen iht. eldiagrammet.
→ „4. Elektrisk tilslutning“

5.9

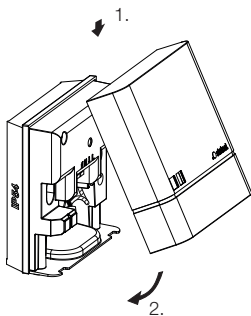

- Sæt kappen på.

5.10

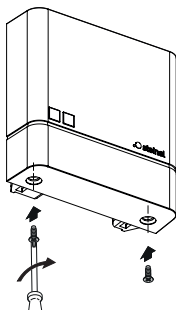

- Skru kappen på.



- Slå strømforsyningen til
 - Indstil funktionerne.
- „6. Funktion“

6. Funktion

NightmatIQ

På NightmatIQ foretages skumringsindstillingen manuelt på potentiometret til skumringsindstilling.



Fare pga. elektrisk strøm!

Berøring af strømførende dele kan give elektrisk stød, forbrændinger eller medføre dødsfald.

- Slå strømmen fra, og afbryd spændingstilførslen.
- Kontrollér med en spændingstester, om spændingen er afbrudt.
- Sørg for, at spændingstilførslen forbliver afbrudt.

- **Standardindstillinger**

- Skumringsindstilling: 75 lux

Skumringsindstilling (G)

Aktiveringslysstyrken (skumring) kan indstilles trinløst fra ca. 1-75 lux.

- ☀ = skumringsindstilling (ca. 75 lux)
- ☾ = skumringsindstilling/natindstilling (ca. 1 lux)

Manuel skumringsindstilling på NightmatIQ

6.1

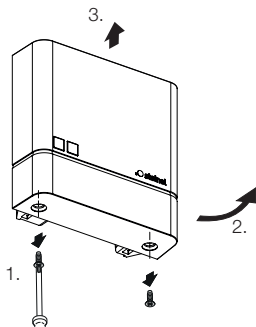

- Afbryd strømforsyningen
- Kontrollér, at spændingstilførslen er afbrudt
- Skru kappen af.

6.2

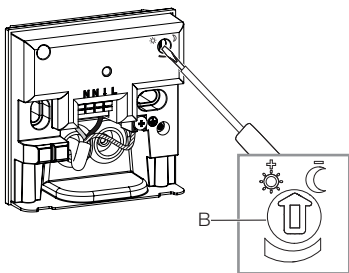

- Indstil skumringsindstillingens ønskede aktiveringstærskel trinløst med en skruetrækker.

6.3

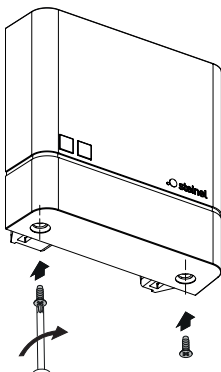

- Skru kappen på.

6.4



- Slå strømforsyningen til.

NightmatIQ Plus

På NightmatIQ Plus foretages indstillingen af funktionerne ved hjælp af Steinel Connect-appen.

Steinel Connect-app

For at konfigurere enheden med smartphone eller tablet skal du downloade STEINEL Connect-appen fra din AppStore. Du skal bruge en smartphone eller tablet med Bluetooth.



Android



iOS



Funktioner, som kan indstilles ved hjælp af Steinel Connect-appen, er:

- Skumringsindstilling.

Bemærk:

Der skal være en minimumsafstand på 3 m til WLAN-routeren og de forskellige Access Points for at undgå fejlfunktioner.

LED-funktion

Initialisering: LED lyser permanent.

Normal tilstand: LED er slukket.

Identificering: LED blinker langsomt.

Firmwareopdatering: LED blinker hurtigt.

Fejl: LED blinker hurtigt.

Standardindstillinger

- Skumringsindstilling: 1.000 lux

Skumringsindstilling

Aktiveringslysstyrken (skumring) kan indstilles trinløst fra ca. 1-1.000 lux.

- ☀ = skumringsindstilling (ca. 1.000 lux)
- ☾ = skumringsindstilling/natindstilling (ca. 1 lux)

Bluetooth-netværkstilslutning (Bluetooth Mesh)

Sensor-omskifteren overholder Bluetooth Mesh-standarden. Den kan tilsluttes i netværk med alle produkter, der opfylder Bluetooth Mesh-standarden.

Sensor-omskifteren konfigureres vha. Steinel Connect-appen. Ved første forbindelse mellem sensor-omskifter og Steinel Connect-app gemmes den passende netværksnøgle på smartphonen eller tabletten. Takket være nøglen er uvedkommende adgang til sensoren udelukket.

Netværksnøglen skal deles, hvis der ønskes adgang via endnu en smartphone eller tablet.

Omskiftningstider

Ud over indstillingen af skumringsværdien kan omskiftningstiderne indstilles via appen, hvor de tilsluttede forbrugere TÆNDES og SLUKKES.

NightmatIQ plus modtager det aktuelle klokkeslæt via Bluetooth-forbindelse med en smartphone/tablet og bruger det til den fremtidige omskiftningshandling.

Hvis spændingsforsyningen til NightmatIQ plus afbrydes, mister den det gemte klokkeslæt. Ud fra solens bane de foregående dage beregner NightmatIQ plus et omtrentligt klokkeslæt. For at gendanne det nøjagtige klokkeslæt skal der oprettes forbindelse med appen igen.

7. Rengøring og vedligeholdelse

Produktet er vedligeholdelsesfrit.



Fare pga. elektrisk strøm!

Hvis vand kommer i kontakt med strømførende dele, kan det medføre elektrisk stød, forbrændinger eller død.

- Rengør kun enheden, hvis den er tør.

Fare for materielle skader!

Produktet kan blive beskadiget pga. forkerte rengøringsmidler.

- Rengør produktet med en let fugtig klud uden rengøringsmiddel.

8. Bortskaffelse

Elapparater, batterier, tilbehør og emballage skal bortskaffes til miljøvenlig genvinding.



Smid ikke elapparater og batterier ud sammen med husholdningsaffaldet!

Kun for EU-lande:

I henhold til det europæiske direktiv om kasserede el- og elektronikapparater og dets implementering i national lovgivning skal kasserede elapparater og batterier sorteres, indsamles og bortskaffes til miljøvenlig genvinding.

9. Producentgaranti

Dette Steinel-produkt er fremstillet med største omhu, funktions- og sikkerhedstestet iht. de gældende forskrifter samt underlagt stikprøvekontrol. Steinel garanterer for upåklagelig beskaffenhed og funktion. Garantien gælder 36 måneder fra den dag, produktet er solgt til forbrugeren. Vi afhjælper mangler, der skyldes materiale- eller fabrikationsfejl, og garantien ydes i form af reparation eller udskiftning af defekte dele efter vores valg. Der ydes ikke garanti ved skader på sliddele, ej heller ved skader og mangler, der er opstået pga. ukorrekt behandling og vedligeholdelse. Yderligere følgeskader på fremmede genstande dækkes ikke.

Garantien gælder kun, hvis den ikke-adskilte enhed sammen med en beskrivelse af fejlen, kassebon eller faktura (købsdato og forhandlerstempel) sendes velemballeret til den pågældende serviceafdeling.

Reparationservice:

Når garantiperioden er udløbet, eller i tilfælde af mangler, der ikke dækkes af garantien, skal du spørge nærmeste serviceværksted om mulighederne for reparation.

3 ÅRS
PRODUCENT
GARANTI

10. Tekniske data

- Mål (H × B × D): 95 × 95 × 38 mm
- Nettilslutning: 220-240 V, 50/60 Hz
- Effektforbrug: *NightmatIQ* < 0,7 W
NightmatIQ plus < 0,5 W
- Skumringsindstilling: *NightmatIQ*: 1-75 lux
NightmatIQ plus: 1-1.000 lux
- Sensorteknik: fototransistor
- Temperaturområde: -20 til +40 °C
- Bluetooth-frekvens (kun *NightmatIQ plus*): 2,4-2,48 GHz
- Bluetooth-seeffekt (kun *NightmatIQ plus*): 4 dBm/2,5 mW
- Kapslingsklasse: IP 54

Brydeevne

- Gløde-/halogenpærelast: 1.000 W
- Lavspændingshalogenpærer: 1.000 VA
- Lysstofrør ukompenseret: 500 VA
- Lysstofrør seriekompenseret: 500 VA
- Lysstofrør parallelkompenseret: 500 VA
- Lysstofrør elektron. forkobl.-enhed: 250 W
- LED-lamper <2W: 100 W
- LED-lamper >2W <8W: 125 W
- LED-lamper >8W: 250 W
- Kapacitiv belastning: 88 µF

11. Afhjælpning af fejl

Enhed uden spænding.

- Sikring ikke slået til eller defekt.
 - Slå sikringen til.
 - Udskift den defekte sikring.
- Ledning afbrudt.
 - Kontrollér ledningen med en spændingstester.
- Kortslutning i nettilførslen.
 - Kontrollér tilslutningerne.
- En eventuel netafbryder er slået fra.
 - Slå netafbryderen til.

Enheden tænder ikke.

- Der er valgt en forkert skumringsindstilling.
 - Indstil skumringsindstillingen igen.
- Netafbryder SLUKKET.
 - Indstil netafbryderen.
- Sikring ikke slået til eller defekt.
 - Slå sikringen til.
 - Udskift den defekte sikring.

Sisällysluettelo

1.	Tämä asiakirja	3
2.	Yleiset turvaohjeet	3
3.	Laitteen osat	4
4.	Sähköliitântä	9
5.	Asennus	10
6.	Toiminta	19
7.	Puhdistus ja hoito	24
8.	Hävittäminen	24
9.	Valmistajan takuu	25
10.	Tekniset tiedot	26
11.	Viankorjaus	27

1. Tämä asiakirja

- Tekijänoikeudellisesti suojattu. Jälkipainatus (myös osittainen) sallittu vain, mikäli annamme siihen luvan.
- Oikeudet teknistä kehitystä palveleviin muutoksiin pidätetään.



Vaaroista ilmoittava varoitus!



Sähköstä aiheutuvista vaaroista ilmoittava varoitus!



Vedestä aiheutuvista vaaroista ilmoittava varoitus!

2. Yleiset turvaohjeet



Käyttöohjeen laiminlyönnistä aiheutuva vaara!

Tämä käyttöohje sisältää tärkeitä laitteen turvalliseen käsittelyyn liittyviä tietoja. Mahdollisiin vaaroihin viitataan erikseen. Ohjeiden noudattamatta jättäminen voi johtaa kuolemaan tai vakaviin vammoihin.

- Lue käyttöohje huolellisesti.
- Huomioi turvaohjeet.
- Säilytä helposti saatavilla.
- Sähkövirta voi johtaa vaarallisiin tilanteisiin. Sähköä johtavien osien koskettaminen voi johtaa sähköiskuun, palovammoihin tai kuolemaan.
- Vain ammattitaitoinen henkilökunta saa tehdä verkkojännitettä koskevat työt.
- Voimassa olevia asennus- ja liitännäsohjeita on noudatettava.
- Käytä ainoastaan alkuperäisiä varaosia.
- Vain ammattirytykset saavat tehdä korjauksia.

3. Laitteen osat

Käyttötarkoituksen mukainen käyttö, NighmatIQ

- Hämärekytkin, soveltuu asennettavaksi seinään sisä- ja ulkotiloissa.
- Hämäryystason asetuksen toiminto säädettävissä säätimellä.
- Voidaan käyttää yksittäisenä tunnistimena.

Käyttötarkoituksen mukainen käyttö, NighmatIQ Plus

- Hämärekytkin, soveltuu asennettavaksi seinään sisä- ja ulkotiloissa.
- Toiminnot säädettävissä Smart Connect -sovelluksen avulla:
- Voidaan käyttää yksittäisenä tunnistimena tai Bluetoothin kautta ryhmään kytkettynä.

Toimintaperiaate

- Hämärekytkin havaitsee valoanturin avulla ympäristön valoisuuden ja vertaa sitä asetettuun valoisuuden kynnsarvoon.
- Liitetty laite kytkeytyy päälle, jos ympäristön valoisuus alittaa valoisuuden kynnsarvon.
- Liitetty laite kytkeytyy pois päältä, jos ympäristön valoisuus ylittää valoisuuden kynnsarvon.

3.1

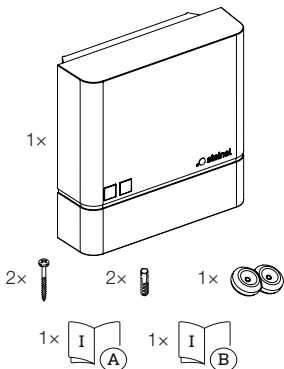

- 1 NightmatIQ / NightmatIQ Plus
- 2 ruuvia
- 2 tulppaa
- 1 tiivistystulppa
- 1 käyttöturvallisuustiedote
- 1 Quick start -opas

Tuotteen mitat NightmatIQ / NightmatIQ Plus

3.2

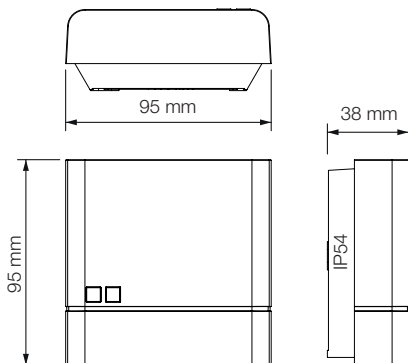

Laitteen yleiskuva NightmatIQ

3.3

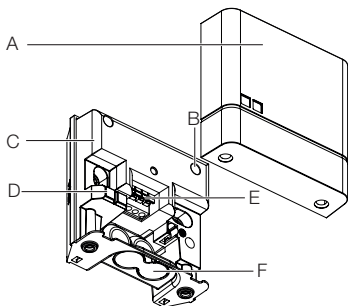

- A Suojus
- B Hämäryystason asetuksen säädin
- C Hämärarytkimen kotelo
- D Valotunnistin
- E Kytkäntäliitin
- F Valinnainen aukko pinta-asennuksen johdotukselle

3.4



- G Yksityiskohta: hämäryystason asetuksen säädin

Laitteen yleiskuva NightmatIQ Plus

3.5

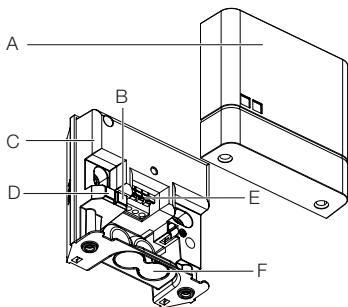

- A Suojus
- B Status-LED
- C Hämääkytkimen kotelo
- D Valotunnistin
- E Kytkenäliitin
- F Valinnainen aukko pinta-asennuksen johdotukselle

4. Sähköliitäntä

Kytchentäkaavio

4.1

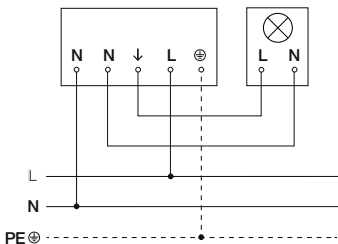

Verkkojohtona käytetään 3-johtimista kaapelia:

- L** = vaihe (useimmiten musta, ruskea tai harmaa)
- N** = nollajohdin (useimmiten sininen)
- PE** = suojamaajohdin (vihreä/keltainen)

Laite voidaan liittää sähköisesti myös verkkokytkimen pe-
rään, kun on varmaa, että verkkokytkin on aina kytkettynä
päälle.

Tiivistystulpat on tarkoitettu verkkojohdolle, jonka ulkohal-
kaisija on 5–10 mm.

5. Asennus



Sähkövirran aiheuttama vaara!

Sähköä johtavien osien koskettaminen voi johtaa sähköiskuun, palovammoihin tai kuolemaan.

- Katkaise virta ja keskeytä virransyöttö.
- Tarkista jännitteettömyys jännitteenkoettimella.
- Varmista, että virransyöttö ei palaudu.

Aineellisten vahinkojen vaara!

Liitântäjohtojen vaihtuminen keskenään voi johtaa oikosulkuun.

- Tunnista liitântäjohdot.
- Yhdistä liitântäjohdot oikein.

Asennuksen valmistelu

- Tarkista, että missään komponentissa ei ole vaurioita. Älä ota laitetta käyttöön, jos siinä on vaurioita.
- Valitse sopiva asennuspaikka.
 - Tärinätön paikka.
 - Ei räjähdysvaarallisille alueille.
 - Ei herkästi syttyville pinnoille.
 - Liitetyn laitteen valolla ei saa olla vaikutusta laitteeseen.

Asennuksen vaiheet

5.1

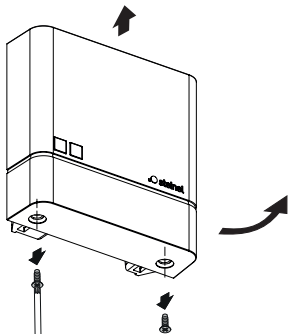

- Katkaise virta.
- Tarkista, että virta on katkaistu.
- Kierrä suojuksen ruuvit irti ja irrota suojus.

5.2

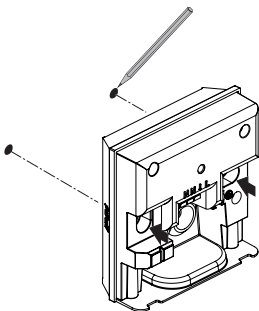

- Merkitse reiät.

5.3

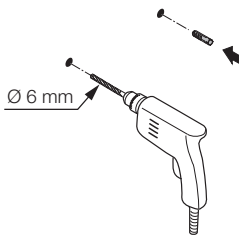

- Pora reiät (ø 6 mm) ja aseta tulpat.

Uppoasennettava malli

5.4

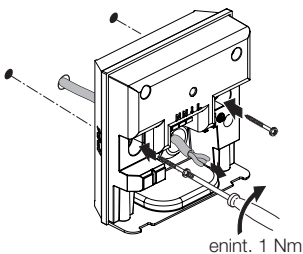

- Ohjaa johto laitteen läpi.
- Ruuvaa laite kiinni enint. 1 Nm:n vääntömomentilla.

Pinta-asennettava malli

5.5

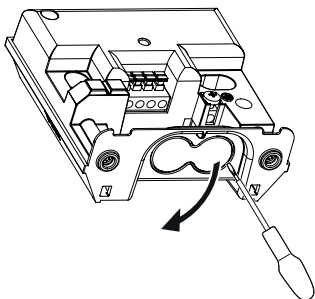

- Murra valinnainen pinta-asennuksen kaapeloinnin aukko varovasti ruuvitaltalla.

5.6

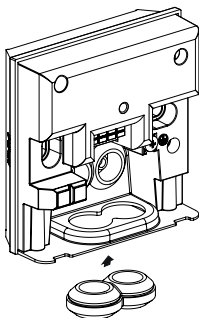

- Aseta tiivistystulpat.

5.7

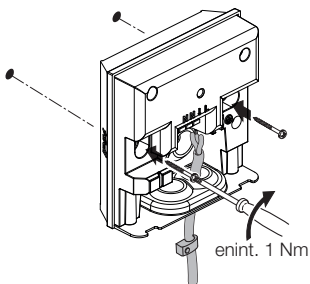

- Ohjaa johto laitteen läpi.
- Ruuvaa laite kiinni enint. 1 Nm:n vääntömomentilla.

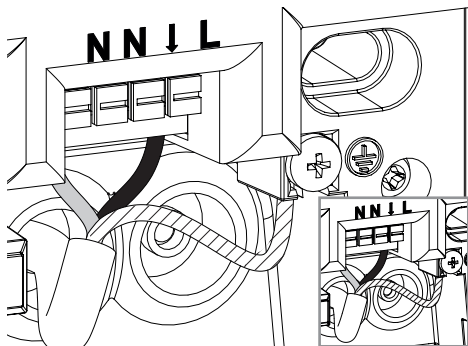

- Liitä verkkojohto kytkentäkaavion mukaisesti.
→ „4. Sähköliitäntä“

5.9

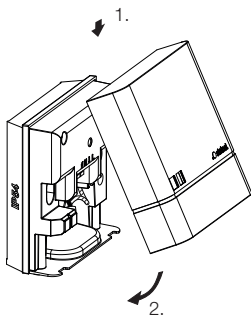

- Aseta suojus paikalleen.

5.10

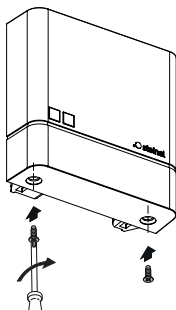

- Kiinnitä suojus.



- Kytke virta päälle.
 - Säädä toiminnot.
- „6. Toiminta“

6. Toiminta

NightmatIQ

NightmatIQ-mallissa hämäryystason asetus tehdään manuaalisesti hämäryystason asetuksen säätimellä.



Sähkövirran aiheuttama vaara!

Sähköä johtavien osien koskettaminen voi johtaa sähköiskuun, palovammoihin tai kuolemaan.

- Katkaise virta ja keskeytä virransyöttö.
- Tarkista jännitteettömyys jännitteenkoettimella.
- Varmista, että virransyöttö ei palaudu.

• Tehdasasetukset

- Hämäryystason asetus: 75 luksia

Hämäryystason asetus (G)

Kytkeytymiskynnys (hämäryystaso) voidaan asettaa portaattomasti n. 1 luksin - 75 luksin välille.

- ☀ = hämäräkäyttö (n. 75 luksia)
- ☾ = hämäräkäyttö / käyttö pimeään aikaan (n. 1 luksi)

Manuaalinen hämäryystason asetus NightmatIQ

6.1

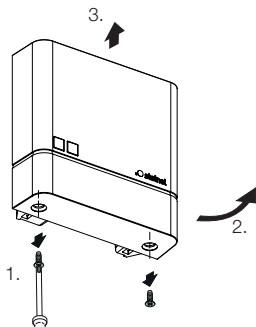

- Katkaise virta.
- Tarkista, että virta on katkaistu.
- Irrota suojus.

6.2

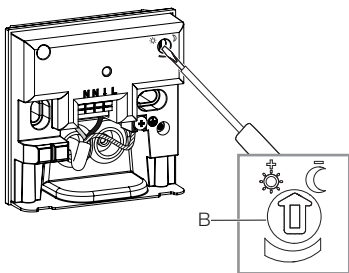

- Säädä hämäryystason asetuksen kytketymiskynnys portaattomasti ruuvitaltalla.

6.3

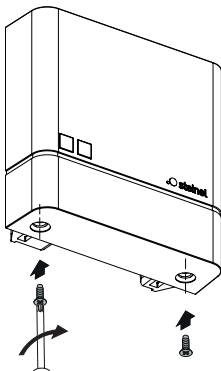

- Kiinnitä suojus.

6.4



- Kytke virta päälle.

NightmatIQ Plus

NightmatIQ Plus -mallissa toimintojen asetus tapahtuu Steinel Connect -sovelluksen avulla.

Steinel Connect -sovellus

STEINEL Connect -sovellus on ladattava AppStoresta älypuhelimien tai tablettitietokoneen avulla tehtävää tunnistimen konfigurointia varten. Tarvitset Bluetooth-kelpoisen älypuhelimien tai tabletin.



Android



iOS



Toiminnot, jotka voidaan säätää Steinel Connect -sovelluksen avulla:

- Hämäryydstason asetus.

Huomautus:

WLAN-reitittimeen ja tukiasemiin on säilytettävä toimintahäiriöiden estämiseksi 3 metrin etäisyys.

LED-toiminto

Alustus:	LED palaa vilkkumatta.
Normaalikäyttö:	LED ei pala.
Tunnistus:	LED vilkkuu hitaasti.
Laiteohjelmiston päivitys:	LED vilkkuu nopeasti.
Virhe:	LED vilkkuu nopeasti.

Tehdasasetukset

- Hämäryystason asetus: 1 000 luksia

Hämäryystason asetus

Kytkeytymiskynnys (hämäryystaso) voidaan asettaa portaattomasti n. 1 luksin - 1 000 luksin välille.

- ☀ = hämärekäyttö (n. 1 000 luksia)
- ☾ = hämärekäyttö / käyttö pimeään aikaan (n. 1 luksi)

Bluetooth-ryhmitys (Bluetooth Mesh)

Tunnistinkytkin vastaa Bluetooth Mesh -standardia. Se voidaan ryhmittää kaikkien Bluetooth Mesh -standardia vastaavien tuotteiden kanssa.

Tunnistinkytkimen määrittäminen tehdään Steinel Connect -sovelluksen avulla. Kun tunnistinkytkin ja Steinel Connect -sovellus yhdistetään ensimmäisen kerran, älypuhelimelle tai tablettitietokoneeseen tallennetaan vastaavat verkkoavaimet. Avaimet estävät tunnistimen luvattoman käytön. Verkkoavain on jaettava, kun tunnistinta halutaan käyttää toisella älypuhelimella tai tablettitietokoneella.

KytKentäajat

Hämäryystason asetuksen lisäksi sovelluksen kautta voidaan säätää myös kytkentäaikoja, joiden mukaisesti liitetyt laitteet kytkeytyvät PÄÄLLE tai POIS PÄÄLTÄ.

NightmatIQ plus vastaanottaa älypuhelimien/tablettien kanssa muodostetun Bluetooth-yhteyden kautta oikean kellonajan ja käyttää sitä seuraaviin kytkentöihin.

Tallennettu kellonaika katoaa muistista, jos NightmatIQ plus -mallin jännitteensyöttö katkeaa. NightmatIQ plus määrittää summittaisen kellonajan edellisten päivien auringon kierron mukaan. Tarkan kellonajan palauttaminen vaatii yhdistämistä uudelleen sovellukseen.

7. Puhdistus ja hoito

Laite on huoltovapaa.



Sähkövirran aiheuttama vaara!

Veden pääseminen kosketuksiin sähköä johtavien osien kanssa voi johtaa sähköiskuun, palovammoihin tai kuolemaan.

- Puhdista laite vain kuivana.

Aineellisten vahinkojen vaara!

Väärin puhdistusaineiden käyttö voi vioittaa laitetta.

- Puhdista laite vain hieman kostutetulla liinalla ilman puhdistusaineita.

8. Hävittäminen

Sähkölaitteet, paristot, tarvikkeet ja pakkaukset on toimitettava ympäristöystävälliseen kierrätykseen.



Älä heitä sähkölaitteita ja paristoja talousjätteiden sekaan!

Koskee vain EU-maita:

Voimassa olevan eurooppalaisen sähkö- ja elektroniikkaromua koskevan direktiivin ja sen kansalliseen lainsäädäntöön saattamisen mukaisesti käyttökelvottomat sähkölaitteet on koottava erikseen ja toimitettava ympäristöystävälliseen kierrätykseen.

9. Valmistajan takuu

Tämä STEINEL-tuote on valmistettu huolellisesti, ja sen toiminta ja turvallisuus on testattu voimassa olevien määräysten mukaisesti. Tuotantoa valvotaan pistokokein. STEINEL myöntää takuun tuotteen moitteettomalle toiminnalle ja rakenteelle. Takuuaika on 36 kuukautta ostopäivästä alkaen. Tänä aikana STEINEL vastaa kaikista materiaali- ja valmistusvioista valintansa mukaan joko korjaamalla tai vaihtamalla vialliset osat. Takuun piiriin eivät kuulu kuluvat osat eivätkä vahingot, jotka ovat aiheutuneet väärästä huollosta tai käsittelystä tai laitteen putoamisesta. Takuu ei koske laitteen muille esineille mahdollisesti aiheuttamia vahinkoja.

Viallinen laite toimitetaan yhdessä lyhyen virhekuvauksen ja ostokuitin kanssa (ostopäivämäärä ja myyjäliikkeen leima) hyvin pakattuna lähimpään huoltopisteeseen. Takuu raukeaa, jos tuotetta on avattu enemmän kuin tuotteen asentaminen vaatii.

Korjauspalvelu

Ota takuuajan jälkeen tai takuun piiriin kuulumattoman vian ollessa kyseessä yhteyttä huoltopalveluumme ja pyydä tietoja korjausmahdollisuuksista.

3 VUODEN
VALMISTAJAN
TAKUU

10. Tekniset tiedot

- Mitat (K x L x S): 95 x 95 x 38 mm
- Verkkoliitäntä: 220–240 V, 50/60 Hz
- Ottoteho: *NightmatIQ* < 0,7 W
NightmatIQ plus < 0,5 W
- Hämäryystason asetus: *NightmatIQ*: 1–75 luksia
NightmatIQ plus: 1–1 000 luksia
- Tunnistintekniikka: fototransistori
- Lämpötila-alue: -20 ... +40 °C
- Bluetooth-taajuus (vain *NightmatIQ plus*): 2,4–2,48 GHz
- Bluetooth-lähetysteho (vain *NightmatIQ plus*):
4 dBm/2,5 mW
- Kotelointiluokka: IP 54

KytKentäteho

- Hehku-/halogeenilampun kuorma: 1 000 W
- Pienjännitehalogeenilamput: 1 000 VA
- Loistelamput, kompensoimaton: 500 VA
- Loistelamput, sarjakompensoitu: 500 VA
- Loistelamput, rinnakkain kompensoitu: 500 VA
- Loistelamput, elektr. liitäntälaitte: 250 W
- LED-lamput <2W: 100 W
- LED-lamput >2W <8W: 125 W
- LED-lamput >8W: 250 W
- Kapasitiivinen kuorma: 88 µF

11. Viankorjaus

Laitteessa ei ole jännitettä.

- Sulaketta ei ole kytketty päälle tai se on viallinen.
 - Kytke sulake päälle.
 - Vaihda viallinen sulake.
- Katkos johdossa.
 - Tarkasta johto jännitteenkoettimella.
- Oikosulku verkkojohdossa.
 - Tarkasta liitännät.
- Valo sammutettu mahdollisesti verkkokytkimellä.
 - Kytke verkkokytkin päälle.

Laite ei kytkeydy päälle.

- Väärä hämäryystason asetus.
 - Säädä hämäryystaso uudelleen.
- Verkkokytkin pois päältä.
 - Säädä verkkokytkin.
- Sulaketta ei ole kytketty päälle tai se on viallinen.
 - Kytke sulake päälle.
 - Vaihda viallinen sulake.

Innhold

1.	Om dette dokumentet	3
2.	Generelle sikkerhetsinstrukser	3
3.	Beskrivelse av enheten	4
4.	Elektrisk tilkobling	9
5.	Montering	10
6.	Funksjon	19
7.	Rengjøring og stell	24
8.	Avfallsbehandling	24
9.	Produsentgaranti	25
10.	Tekniske spesifikasjoner	26
11.	Utbedring av feil	27

1. Om dette dokumentet

- Med opphavsrett. Ettertrykk, også i utdrag, kun med vår tillatelse.
- Det tas forbehold om endringer som tjener tekniske fremskritt.



Advarsel om fare!



Advarsel om fare på grunn av strøm!



Advarsel om fare på grunn av vann!

2. Generelle sikkerhetsinstrukser



Fare dersom bruksanvisningen ignoreres!

Denne anvisningen inneholder viktig informasjon for sikker bruk av enheten. Det gjøres ekstra oppmerksom på mulige farer. Ignorerer disse, kan dette føre til død eller alvorlige personskader.

- Les bruksanvisningen nøye.
- Følg sikkerhetsinstruksene.
- Oppbevar bruksanvisningen tilgjengelig.
- Bruk av elektrisk strøm kan føre til farlige situasjoner. Berøring av strømførende deler kan føre til elektrisk sjokk, forbrenninger eller død.
- Arbeid på nettspenningen skal kun utføres av kvalifisert fagpersonale.
- Følg nasjonale installasjonsforskrifter og tilkoblingskrav (f.eks. DE: VDE 0100, AT: ÖVE-ÖNORM E8001-1, CH: SEV 1000).
- Bruk kun originale reservedeler.
- Reparasjoner skal kun utføres av fagbedrifter.

3. Beskrivelse av enheten

Forskriftsmessig bruk NightmatIQ

- Skumringsbryter til montering på vegg innen- og utendørs.
- Funksjonen skumringsinnstilling kan justeres via potensiometer.
- Kan brukes som enkeltsensor.

Forskriftsmessig bruk NightmatIQ Plus

- Skumringsbryter til montering på vegg innen- og utendørs.
- Funksjoner kan stilles inn via Steinel Connect-appen.
- Kan brukes som enkeltsensor eller sammenkoblet via Bluetooth.

Funksjon

- Ved hjelp av lyssensoren registrerer skumringsbryteren lysstyrken i omgivelsene og sammenligner den med innstilt lysstyrketerskel.
- Ligger lysstyrken i omgivelsene under lysstyrketerskelen, slås den tilkoblede lampen på.
- Ligger lysstyrken i omgivelsene over lysstyrketerskelen, slås den tilkoblede lampen av.

Leveringsomfang NightmatIQ / NightmatIQ Plus

3.1

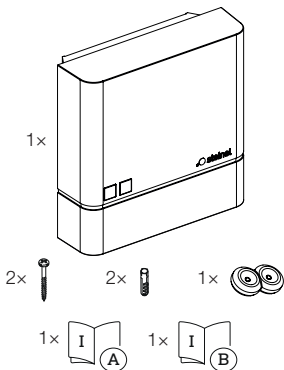

- 1 NightmatIQ / NightmatIQ Plus
- 2 skruer
- 2 murplugger
- 1 tetningsplugg
- 1 sikkerhetsdatablad
- 1 hurtigstart

Produktmål NightmatIQ / NightmatIQ Plus

3.2

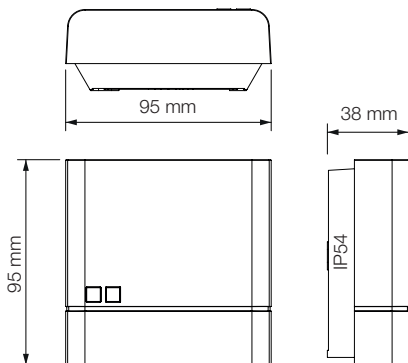

Oversikt over enheten NightmatIQ

3.3

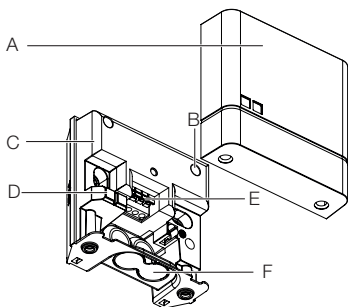

- A Deksel
- B Potensiometer skumringsinnstilling
- C Hus skumringsbryter
- D Lysstyrkesensor
- E Koblingsklemme
- F Om ønsket: åpning for åpen ledningsføring

3.4



- G Detalj: potensiometer skumringsinnstilling

Oversikt over enheten NightmatIQ Plus

3.5

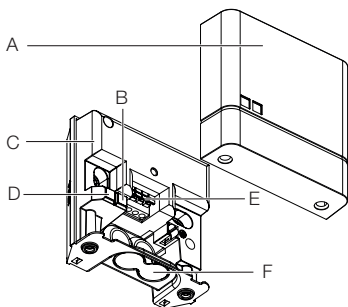

- A Deksel
- B Status-LED
- C Hus skumringsbryter
- D Lysstyrkesensor
- E Koblingsklemme
- F Om ønsket: åpning for åpen ledningsføring

4. Elektrisk tilkobling

Koblings skjema

4.1

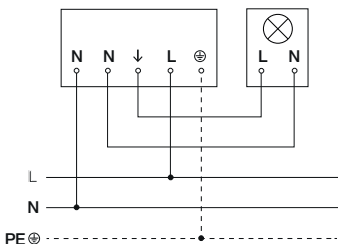

Nettledningen består av en 3-ledet kabel:

- L** = fase (som regel svart, brun eller grå)
- N** = nulleder (som regel blå)
- PE** = jordleder (grønn/gul)

Enheten kan også kobles elektrisk til etter en ledningsbryter, dersom det er sikret at ledningsbryteren er permanent på.

Tetningspluggene er til bruk for en nettledning med utvendig diameter på 5–10 mm.

5. Montering



Elektrisk strøm kan utgjøre fare!

Berøring av strømførende deler kan føre til elektrisk sjokk, forbrenninger eller død.

- Slå av strømmen og stans strømtilførselen.
- Bruk en spenningstester til å kontrollere at ledningen er strømfri.
- Påse at strømtilførselen forblir stanset.

Fare for materielle skader!

Forveksles tilkoblingsledningene, kan dette føre til kortslutning.

- Identifiser tilkoblingsledningene.
- Koble tilkoblingsledningene korrekt til.

Forberede montering

- Kontroller alle komponenter for skader. Ikke ta enheten i bruk hvis den er skadet.
- Velg et egnet monteringssted.
 - Vibrasjonsfritt.
 - Ikke i eksplosive omgivelser.
 - Ikke på lett antenkelige overflater.
 - Apparatet må ikke påvirkes av lyset fra den tilkoblede lampen.

Fremgang ved montering:

5.1

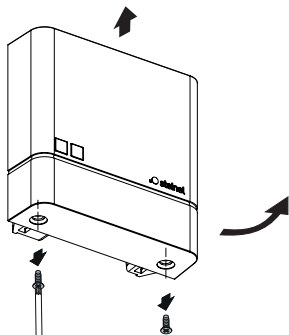

- Slå av strømtilførselen
- Sjekk at strømtilførselen er stanset.
- Skru av dekselet og trekk det av.

5.2

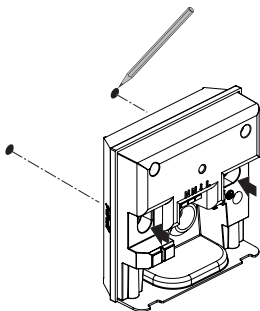

- Tegn borehull

5.3

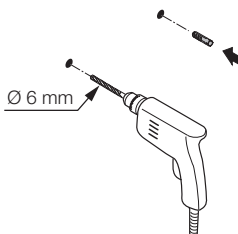

- Bor hull (Ø 6 mm) og sett inn plugger.

Skjult variant

5.4

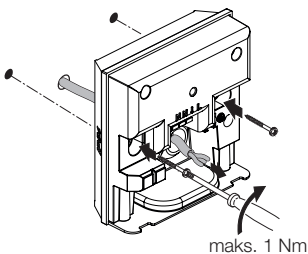

- Før kablen gjennom apparatet.
- Skru fast apparatet med et dreiemoment på maks. 1 Nm.

Åpen variant

5.5

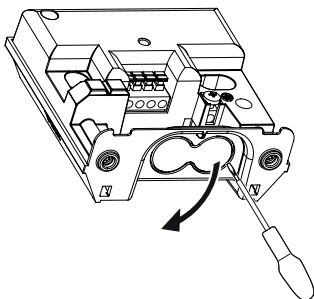

- Trykk åpningen for åpen kabelføring forsiktig ut med en skrutrekker.

5.6



- Sett inn tetningsplugg

5.7

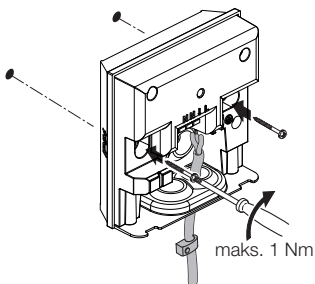

- Før kablen gjennom apparatet.
- Skru fast apparatet med et dreiemoment på maks. 1 Nm.

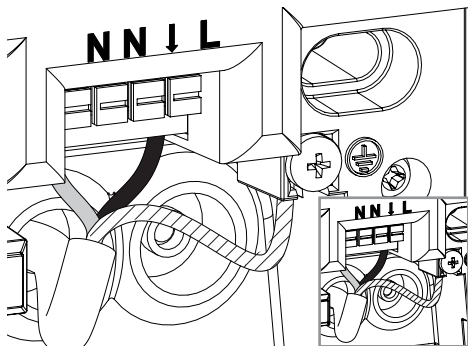

- Koble nettleidingen til iht. koblingskjemaet.
→ „4. Elektrisk tilkobling“

5.9

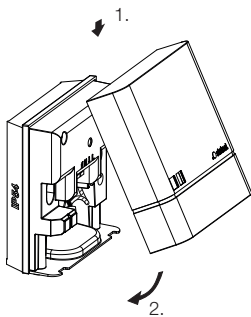

- Sett på dekselet.

5.10

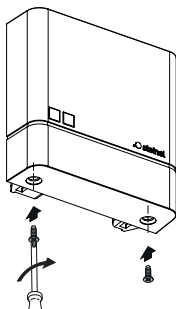

- Skru fast dekselet.



- Slå på strømtilførselen
 - Still inn funksjonene.
- „6. Funksjon“

6. Funksjon

NightmatIQ

På NightmatIQ foretas skumringsinnstillingen manuelt via potensiometer skumringsinnstillingen.



Elektrisk strøm kan utgjøre fare!

Berøring av strømførende deler kan føre til elektrisk sjokk, forbrenninger eller død.

- Slå av strømmen og stans strømtilførselen.
- Bruk en spenningstester til å kontrollere at ledningen er strømfri.
- Påse at strømtilførselen forblir stanset.

- **Fabrikkinnstillinger**

- Skumringsinnstilling: 75 lux

Skumringsinnstilling (G)

Ønsket reaksjonsnivå (skumring) kan stilles trinnløst inn fra ca. 1-75 lux.

- ☀ = skumringsmodus (ca. 75 lux)
- ☾ = skumringsmodus/nattmodus (ca. 1 lux)

Manuell skumringsinnstilling NightmatIQ

6.1

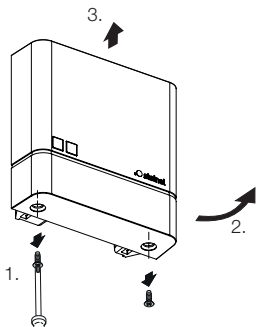

- Slå av strømtilførselen
- Sjekk at strømtilførselen er stanset.
- Skru av dekselet.

6.2

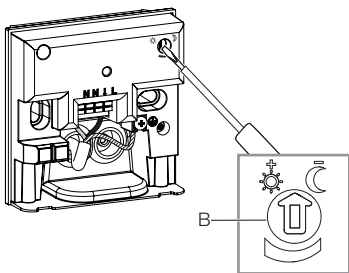

- Still ønsket reaksjonsnivå for skumringsinnstillingen trinnløst inn skrutrekkeren.

6.3

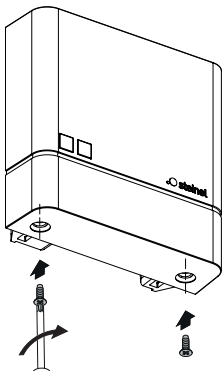

- Skru fast dekselet.

6.4



- Slå på strømtilførselen

NightmatIQ Plus

På NightmatIQ Plus stilles funksjonene inn via Steinel Connect-appen.

Steinel Connect-app

For å konfigurere enheten med smarttelefon eller nettbrett må du laste ned STEINEL Connect-appen fra app-butikken din. Du trenger en Bluetooth-kompatibel smarttelefon eller nettbrett.



Android



iOS



Funksjoner som kan stilles inn via Steinel Connect-appen:

- Skumringsinnstilling.

NB:

For å utelukke feilstasjoner må det overholdes en minsteavstand på 3 m til WiFi-ruteren og basestasjonene.

LED-funksjon

Initialisering: LED lyser permanent.

Normal modus: LED av.

Identifisering: LED blinker langsomt.

Fastvare-oppdatering: LED blinker raskt.

Feil: LED blinker raskt

Fabrikkinstillinger

- Skumringsinnstilling: 1 000 lux

Skumringsinnstilling

Ønsket reaksjonsnivå (skumring) kan stilles trinnløst inn fra ca. 1-1 000 lux.

- ☀ ALIGN (ca. 1000 lux)
- ☾ ALIGN nattmodus (ca. 1 lux)

Bluetooth-tilkobling (Bluetooth Mesh)

Sensorbryteren oppfyller kravene i Bluetooth Mesh-standard. Den kan kobles til alle produkter som oppfyller kravene i Bluetooth Mesh-standard.

Sensorbryteren konfigureres via Steinel Connect-appen. Ved første gangs forbindelse mellom sensorbryteren og Steinel Connect-appen blir det lagret en tilhørende nettverksnøkkel på smarttelefonen eller nettbrettet. Med denne nøkkelen er uvedkommende tilgang til sensoren utelukket. Nettverksnøkkelen må deles for tilgang via en ytterligere smarttelefon eller et videre nettbrett.

Belysningstider

I tillegg til skumringsverdien kan også belysningstidene for når tilkoblede lamper slås PÅ eller AV stilles inn via appen. Fra Bluetooth-forbindelsen med en smarttelefon/et nettbrett får NightmatIQ plus aktuelt klokkeslett og bruker dette for fremtidige koblinger.

Avbrytes spenningsforsyningen til NightmatIQ plus, mister den det lagrede klokkeslettet. Basert på solens gang de siste dagene, beregner NightmatIQ plus et omtrentlig klokkeslett. For å gjenopprette presist klokkeslett må den kobles opp til appen igjen.

7. Rengjøring og stell

Enheten er vedlikeholdsfri.



Elektrisk strøm kan utgjøre fare!

Kommer strømførende deler i kontakt med vann, kan dette føre til elektrisk sjokk, forbrenninger eller død.

- Enheten skal kun rengjøres når den er tørr.

Fare for materielle skader!

Bruk av feil rengjøringsmiddel kan skade enheten.

- Rengjør enheten med en lett fuktig klut uten rengjøringsmiddel.

8. Avfallsbehandling

Elektriske apparater, batterier, tilbehør og emballasje skal resirkuleres på en miljøvennlig måte.



Ikke kast elektriske apparater og batterier i husholdningsavfallet.

Gjelder kun EU-land:

I henhold til gjeldende europeisk direktiv om elektrisk og elektronisk avfall, og i samsvar med nasjonal lovgivning, skal elektriske apparater og batterier som ikke lenger kan benyttes, kildesorteres og gjenvinnes på en miljøvennlig måte.

9. Produsentgaranti

Dette Steinel-produktet er fremstilt med største nøyaktighet. Det er testet mht. funksjon og sikkerhet i henhold til gjeldende forskrifter og deretter underkastet en stikkprøvekontroll. Steinel gir full garanti for feilfri kvalitet og funksjon. Garantitiden utgjør 36 måneder, regnet fra dagen apparatet ble solgt til forbrukeren. Vi utbedrer mangler som kan føres tilbake til fabrikkasjonsfeil eller feil ved materialene. Garantien ytes ved reparasjon eller ved at deler med feil byttes ut. Garantien bortfaller ved skader på slitasjedeler, eller ved skader eller mangler som er oppstått som følge av ukyndig bruk eller vedlikehold. Følgeskader ved bruk (skader på andre gjenstander) dekkes ikke av garantien.

Garantien ytes bare hvis hele apparatet pakkes godt inn og sendes til importøren. Legg ved en kort beskrivelse av feilen samt kvittering eller regning (kjøpsdato og forhandlers stempel).

Reparasjonsservice

Etter garantitidens utløp, eller ved mangler som ikke dekkes av garantien, kan du spørre forhandleren om muligheter for reparasjon.

3 Å R S
PRODUSENT
GARANTI

10. Tekniske spesifikasjoner

- Mål (h x h x d): 95 x 95 x 38 mm
- Nettilkobling: 220-240 V, 50/60 Hz
- Effektopptak: *NightmatIQ* < 0,7 W
NightmatIQ plus < 0,5 W
- Skumringsinnstilling: *NightmatIQ*: 1-75 Lux
NightmatIQ plus: 1-1000 lux
- Sensorsystem: fototransistor
- Temperaturområde: -20 til +40 °C
- Frekvens Bluetooth (kun *NightmatIQ plus*): 2,4-2,48 GHz
- Sendeeffekt Bluetooth (kun *NightmatIQ plus*): 4 dBm/2,5 mW
- Kapslingsgrad: IP 54

Koblingseffekt

- Lyspære-/halogenlampelast: 1000 W
- Lavvoltage-halogenlamper: 1000 VA
- Lysrør ukompensert: 500 VA
- Lysrør seriekompensert: 500 VA
- Lysrør parallellkompensert: 500 VA
- Lysrør elektronisk ballast: 250 W
- LED-lamper <2W: 100 W
- LED-lamper >2W <8W: 125 W
- LED-lamper <8W: 250 W
- Kapasitiv belastning: 88 µF

11. Utbedring av feil

Enheden har ikke spenning.

- Sikringen ikke innkoblet eller defekt.
 - Koble inn sikringen.
 - Skift ut defekt sikring.
- Brudd på ledningen.
 - Kontroller ledningen med spenningstester.
- Kortslutning i nettleddningen.
 - Kontroller koblingene.
- En eventuell ledningsbryter er slått av
 - Slå på nettbryteren.

Enheden kobles ikke inn.

- Ikke korrekt valgt skumringsinnstilling.
 - Still inn skumringsinnstillingen på nytt.
- Ledningsbryter er AV.
 - Still inn ledningsbryteren.
- Sikringen ikke innkoblet eller defekt.
 - Koble inn sikringen.
 - Skift ut defekt sikring.

Περιεχόμενα

1.	Σχετικά με αυτό το έγγραφο	3
2.	Γενικές υποδείξεις ασφάλειας	3
3.	Περιγραφή συσκευής	4
4.	Ηλεκτρική σύνδεση	9
5.	Συναρμολόγηση	10
6.	Λειτουργία	19
7.	Καθαρισμός και φροντίδα	24
8.	Απόσυρση	24
9.	Εγγύηση κατασκευαστή	25
10.	Τεχνικά δεδομένα	26
11.	Αποκατάσταση βλάβης	27

1. Σχετικά με αυτό το έγγραφο

- Κατοχυρωμένη τεχνογνωσία. Ανατύπωση, ακόμα και αποσπασματικά, μόνο κατόπιν δικής μας έγκρισης.
- Με επιφύλαξη τροποποιήσεων, οι οποίες εξυπηρετούν στην τεχνολογική πρόοδο.



Προειδοποίηση ενώπιον κινδύνων!



Προειδοποίηση ενώπιον κινδύνου λόγω ρεύματος!



Προειδοποίηση ενώπιον κινδύνου λόγω νερού!

2. Γενικές υποδείξεις ασφαλείας



Κίνδυνος λόγω μη τήρησης των οδηγιών χρήσης!

Οι παρούσες οδηγίες περιέχουν σημαντικές πληροφορίες για τον ασφαλή χειρισμό της συσκευής. Επισημαίνεται ιδιαίτερα η προσοχή σε δυνητικούς κινδύνους. Η μη τήρηση μπορεί να προκαλέσει θάνατο ή σοβαρούς τραυματισμούς.

- Διαβάζετε προσεκτικά τις οδηγίες.
- Ακολουθείτε τις υποδείξεις ασφαλείας.
- Φυλάσσετε σε προσβάσιμο μέρος.
- Η χρήση ηλεκτρικού ρεύματος μπορεί να οδηγήσει σε επικίνδυνες καταστάσεις. Η επαφή ρευματοφόρων εξαρτημάτων μπορεί να προκαλέσει ηλεκτρικό σοκ, εγκαύματα ή και θάνατο.
- Η εργασία σε ηλεκτρική τάση πρέπει να εκτελείται από εξειδικευμένο προσωπικό.
- Πρέπει να τηρούνται οι συνήθεις προδιαγραφές εγκατάστασης και οι όροι σύνδεσης που ισχύουν στην εκάστοτε χώρα (π.χ. DE: VDE 0100, AT: ÖVE-ÖNORM E8001-1, CH: SEV 1000).

- Χρησιμοποιείτε μόνο γνήσια ανταλλακτικά.
- Οι επιδιορθώσεις επιτρέπονται μόνο από αρμόδιους τεχνικούς.

3. Περιγραφή συσκευής

Χρήση σύμφωνα με τους κανονισμούς NighmatIQ

- Ο διακόπτης ευαισθησίας είναι κατάλληλος για εγκατάσταση σε τοίχο σε εσωτερικούς και εξωτερικούς χώρους.
- Λειτουργία ρύθμισης λυκόφωτος, ρυθμιζόμενη μέσω ποτενσιόμετρου.
- Διαθέσιμος ως μεμονωμένος αισθητήρας.

Χρήση σύμφωνα με τους κανονισμούς NighmatIQ Plus

- Ο διακόπτης ευαισθησίας είναι κατάλληλος για εγκατάσταση σε τοίχο σε εσωτερικούς και εξωτερικούς χώρους.
- Οι λειτουργίες είναι ρυθμίσιμες μέσω εφαρμογής Steinel Connect:
- Διαθέσιμος ως μεμονωμένος αισθητήρας δικτυωμένος με Bluetooth.

Αρχή λειτουργίας

- Ο διακόπτης ευαισθησίας καταγράφει με τη βοήθεια αισθητήρα φωτός τη φωτεινότητα του περιβάλλοντος και τη συγκρίνει με την ρυθμισμένη οριακή τιμή φωτεινότητας.
- Εάν η φωτεινότητα του περιβάλλοντος είναι μικρότερη από την οριακή τιμή φωτεινότητας, ενεργοποιείται ο συνδεδεμένος καταναλωτής.
- Εάν η φωτεινότητα του περιβάλλοντος είναι μεγαλύτερη από την οριακή τιμή φωτεινότητας, απενεργοποιείται ο συνδεδεμένος καταναλωτής.

Περιεχόμενα παράδοσης NightmatIQ / NightmatIQ Plus

3.1

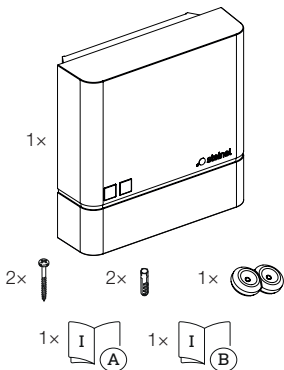

- 1 NightmatIQ / NightmatIQ Plus
- 2 βίδες
- 2 τακάκια
- 1 Στεγανοποιητική τάπα
- 1 φυλλάδιο δεδομένων ασφάλειας
- 1 γρήγορη εκκίνηση

Διαστάσεις προϊόντος NightmatIQ / NightmatIQ Plus

3.2

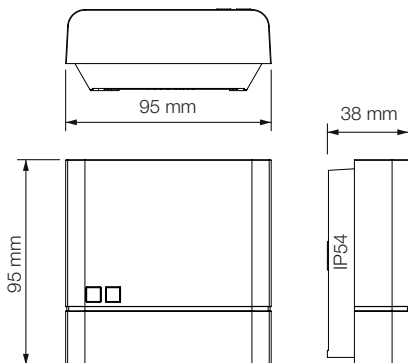

Επισκόπηση συσκευής NightmatIQ

3.3

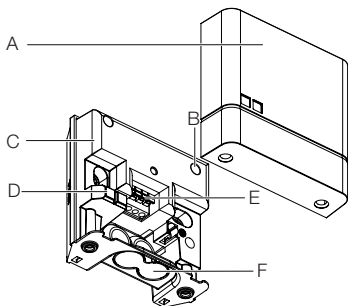

- A Κάλυμμα
- B Ποτενσιόμετρο ρύθμισης ευαισθησίας
- C Περίβλημα διακόπτη ευαισθησίας
- D Αισθητήρας φωτεινότητας
- E Ακροδέκτης σύνδεσης
- F Προαιρετικό άνοιγμα για εξωτοίχια καλωδίωση

3.4



- G Λεπτομέρειες: Ποτενσιόμετρο ρύθμισης ευαισθησίας

Επισκόπηση συσκευής NightmatIQ Plus

3.5

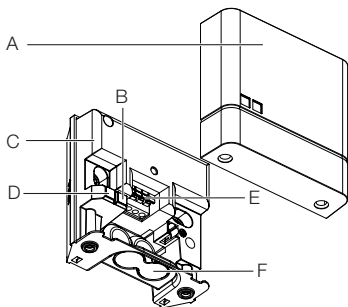

- A Κάλυμμα
- B Κατάσταση LED
- C Περίβλημα διακόπτη ευαισθησίας
- D Αισθητήρας φωτεινότητας
- E Ακροδέκτης σύνδεσης
- F Προαιρετικό άνοιγμα για εξωτοίχια καλωδίωση

4. Ηλεκτρική σύνδεση

Διάγραμμα συνδεσμολογίας

4.1

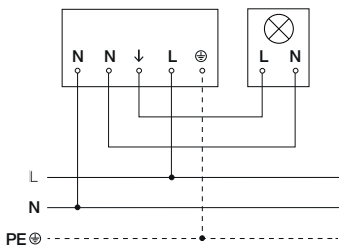

Ο αγωγός τροφοδοσίας αποτελείται από καλώδιο 3 συρμάτων:

L = Φάση (συνήθως μαύρο, καφέ ή γκρι)

N = Ουδέτερος αγωγός (συνήθως μπλε)

PE = Αγωγός γείωσης (πράσινο/κίτρινο)

Η συσκευή μπορεί επίσης να συνδεθεί μετά από διακόπτη δικτύου, όταν διασφαλίζεται το γεγονός ότι ο διακόπτης δικτύου παραμένει σταθερά ενεργοποιημένος.

Οι στεγανοποιητικές τάπες προβλέπονται για αγωγό τροφοδοσίας με εξωτερική διάμετρο 5-10 mm.

5. Συναρμολόγηση



Κίνδυνος λόγω ηλεκτρικού ρεύματος!

Η επαφή ρευματοφόρων εξαρτημάτων μπορεί να προκαλέσει ηλεκτρικό σοκ, εγκαύματα ή και θάνατο.

- Απενεργοποιείτε το ηλεκτρικό ρεύμα και διακόπτετε την τροφοδοσία τάσης.
- Ελέγχετε με δοκιμαστικό τάσης αν έχει διακοπεί η τροφοδοσία τάσης.
- Βεβαιωθείτε ότι η τροφοδοσία τάσης παραμένει διακεκομμένη.

Κίνδυνος υλικών ζημιών!

Η αντιστροφή των αγωγών σύνδεσης μπορεί να προκαλέσει βραχυκύκλωμα.

- Προσδιορίστε τους αγωγούς σύνδεσης.
- Συνδέστε σωστά τους αγωγούς σύνδεσης.

Προετοιμασία εγκατάστασης

- Ελέγχετε όλα τα εξαρτήματα για τυχόν ζημιές. Σε περίπτωση βλαβών δεν επιτρέπεται η λειτουργία της συσκευής.
- Επιλέγεται κατάλληλο σημείο εγκατάστασης.
 - Χωρίς κραδασμούς.
 - Όχι σε περιοχές που παρουσιάζουν κίνδυνο έκρηξης.
 - Όχι επάνω σε εύφλεκτες επιφάνειες.
 - Η συσκευή απαγορεύεται να επηρεάζεται από το φως του συνδεδεμένου καταναλωτή.

Βήματα εγκατάστασης

5.1

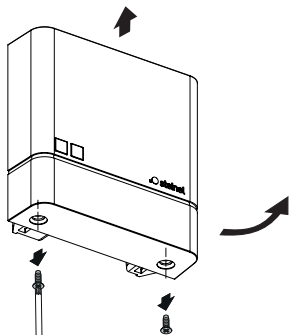

- Διακόπτετε την τροφοδοσία ρεύματος.
- Ελέγχετε ότι η τροφοδοσία τάσης είναι απενεργοποιημένη.
- Ξεβιδώστε και αφαιρέστε το κάλυμμα.

5.2

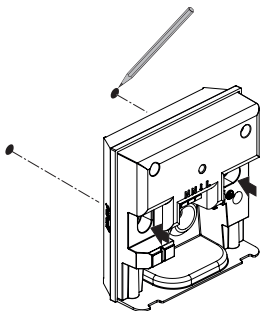

- Σημαδεύετε τα σημεία για τρύπες.

5.3

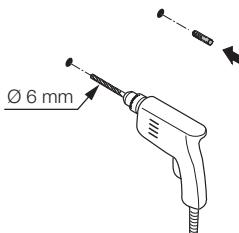

- Ανοίγετε τρύπες (ø 6 mm) και τοποθετείτε ούπατ.

Ενδοτοίχια παραλλαγή

5.4

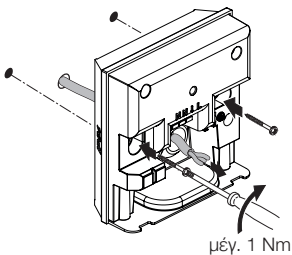

- Περάστε το καλώδιο μέσα από τη συσκευή.
- Βιδώστε τη συσκευή με ροπή στρέψης μέγ. 1 Nm.

Εξωτοίχια παραλλαγή

5.5

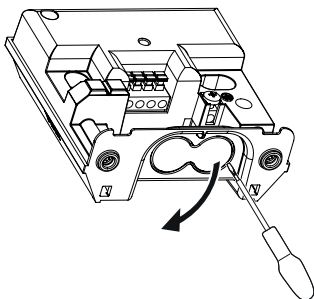

- Σπάστε το προαιρετικό άνοιγμα για την εξωτοίχια καλωδίωση προσεκτικά με ένα κατσαβίδι.

5.6



- Τοποθετείτε στεγανοποιητική τάπα.

5.7

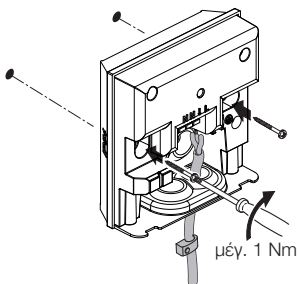

- Περάστε το καλώδιο μέσα από τη συσκευή.
- Βιδώστε τη συσκευή με ροπή στρέψης μέγ. 1 Nm.

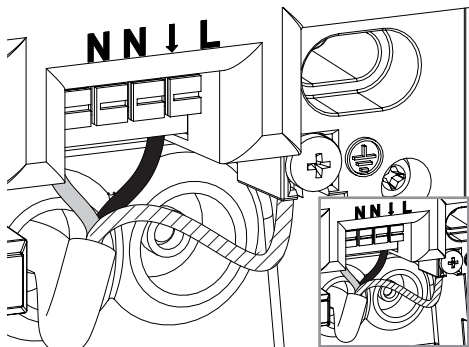

- Συνδέετε τον αγωγό ρεύματος σύμφωνα με το σχέδιο συνδεσμολογίας.
- „4. Ηλεκτρική σύνδεση“

5.9

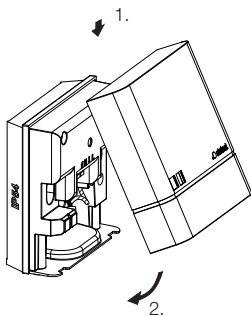

- Τοποθετήστε το κάλυμμα.

5.10

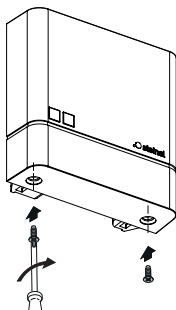

- Βιδώστε το κάλυμμα.



- Ενεργοποιείτε την τροφοδοσία ρεύματος.
 - Ρυθμίστε τις λειτουργίες.
- „6. Λειτουργία“

6. Λειτουργία

NightmatIQ

Στο NightmatIQ η ρύθμιση ευαισθησίας πραγματοποιείται χειροκίνητα μέσω ποτενσιόμετρου ρύθμισης ευαισθησίας.



Κίνδυνος λόγω ηλεκτρικού ρεύματος!

Η επαφή ρευματοφόρων εξαρτημάτων μπορεί να προκαλέσει ηλεκτρικό σοκ, εγκαύματα ή και θάνατο.

- Απενεργοποιείτε το ηλεκτρικό ρεύμα και διακόπτετε την τροφοδοσία τάσης.
- Ελέγχετε με δοκιμαστικό τάσης αν έχει διακοπεί η τροφοδοσία τάσης.
- Βεβαιωθείτε ότι η τροφοδοσία τάσης παραμένει διακεκομμένη.

- **Ρυθμίσεις εργοστασίου**

- Ρύθμιση ευαισθησίας: 75 Lux

Ρύθμιση ευαισθησίας (G)

Η φωτεινότητα απόκρισης (λυκόφως) μπορεί να ρυθμιστεί αδιαβάθμητα από περ. 1-75 Lux.

- ☀ = Λειτουργία λυκόφωτος (περ. 75 Lux)
- ☾ = Λειτουργία λυκόφωτος (περ. 1 Lux)

Χειροκίνητη ρύθμιση ευαισθησίας NightmatIQ

6.1

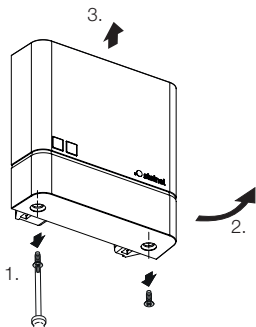

- Διακόπτετε την τροφοδοσία ρεύματος.
- Ελέγχετε ότι η τροφοδοσία τάσης είναι απενεργοποιημένη.
- Ξεβιδώστε το κάλυμμα.

6.2

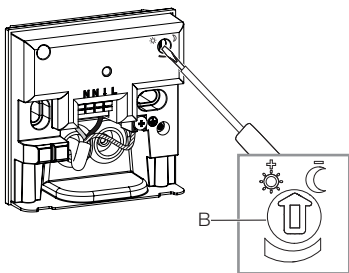

- Το επιθυμητό όριο ευαισθησίας της ρύθμισης ευαισθησίας μπορεί να ρυθμιστεί αδιαβάθμητα με το κατσαβίδι.

6.3

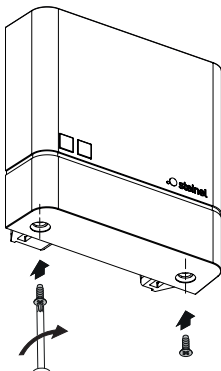

- Βιδώστε το κάλυμμα.

6.4



- Ενεργοποιείτε την τροφοδοσία ρεύματος.

NightmatIQ Plus

Στο NightmatIQ Plus η ρύθμιση των λειτουργιών πραγματοποιείται μέσω της εφαρμογής Steinel Connect App.

Εφαρμογή Steinel Connect

Για τη ρύθμιση της συσκευής με Smartphone ή Tablet, πρέπει να κατεβάσετε την εφαρμογή STEINEL Connect από το δικό σας AppStore. Απαιτείται ένα smartphone ή tablet με δυνατότητα Bluetooth.



Android



iOS



Οι ακόλουθες λειτουργίες είναι ρυθμίσιμες μέσω εφαρμογής Steinel Connect:

- Ρύθμιση ευαισθησίας.

Υπόδειξη:

Πρέπει να διατηρείται ελάχιστη απόσταση 3 m από το WLAN-Router και τα Access Point, προς αποφυγή ελαττωματικών λειτουργιών.

Λειτουργία LED

Αρχικοποίηση: Το LED ανάβει διαρκώς.

Κανονική λειτουργία: Το LED σβήνει

Αρχικοποίηση Bluetooth: Το LED αναβοσβήνει αργά.

Ενημέρωση υλικολογισμικού: Το LED αναβοσβήνει γρήγορα.

Σφάλμα: Το LED αναβοσβήνει γρήγορα

Ρυθμίσεις εργοστασίου

- Ρύθμιση ευαισθησίας: 1.000 Lux

Ρύθμιση ευαισθησίας

Η φωτεινότητα απόκρισης (λυκόφως) μπορεί να ρυθμιστεί αδιαβάθμητα από περ. 1-1.000 Lux.

- ☀ = Λειτουργία λυκόφωτος (περ. 1.000 Lux)
- ☾ = Λειτουργία λυκόφωτος (περ. 1 Lux)

Δικτύωση Bluetooth (Bluetooth Mesh)

Ο διακόπτης αισθητήρα ανταποκρίνεται στο πρότυπο Bluetooth Mesh. Μπορεί να δικτυωθεί με όλα τα προϊόντα που ανταποκρίνονται σε πρότυπο Bluetooth Mesh.

Η διαμόρφωση του διακόπτη αισθητήρα πραγματοποιείται μέσω της εφαρμογής Steinel Connect. Κατά την πρώτη σύνδεση μεταξύ διακόπτη αισθητήρα και εφαρμογής Steinel Connect αποθηκεύεται στο Smartphone ή το Tablet το σχετικό κλειδί δικτύου. Αποκλείεται η αναρμόδια πρόσβαση στον αισθητήρα μέσω του κλειδιού.

Για πρόσβαση από άλλο Smartphone ή Tablet πρέπει να μοιραστεί το κλειδί δικτύου.

Χρόνοι μεταγωγής

Εκτός από τη ρύθμιση για τιμή ευαισθησίας, μπορείτε μέσω της εφαρμογής να ρυθμίσετε και τους χρόνους μεταγωγής, κατά τους οποίους θα ενεργοποιούνται ή θα απενεργοποιούνται οι συνδεδεμένοι καταναλωτές.

Το NightmatIQ plus λαμβάνει μέσω σύνδεσης Bluetooth με Smartphone/Tablet την πραγματική ώρα και τη χρησιμοποιεί για το μελλοντικό χειρισμό μεταγωγής.

Σε περίπτωση διακοπής τροφοδοσία τάσης του NightmatIQ plus, η αποθηκευμένη ώρα χάνεται. Βάση της θέσης του ήλιου της προηγούμενης ημέρας, το NightmatIQ plus χρησιμοποιεί μία κατά προσέγγιση ώρα. Για επαναφορά της ώρας ακριβείας, απαιτείται εκ νέου σύνδεση με την εφαρμογή.

7. Καθαρισμός και φροντίδα

Η συσκευή δεν χρειάζεται συντήρηση.



Κίνδυνος λόγω ηλεκτρικού ρεύματος!

Η επαφή του νερού με ρευματοφόρα εξαρτήματα μπορεί να προκαλέσει ηλεκτρικό σοκ, εγκαύματα ή και θάνατο.

- Καθαρίστε τη συσκευή σε στεγνή κατάσταση.

Κίνδυνος υλικών ζημιών!

Η χρήση λανθασμένου απορρυπαντικού μπορεί να προκαλέσει ζημιά στη συσκευή.

- Καθαρίστε τη συσκευή με ένα ελαφρά νοτισμένο πανί χωρίς απορρυπαντικό.

8. Απόσυρση

Οι ηλεκτρικές συσκευές, οι μπαταρίες, τα εξαρτήματα και οι συσκευασίες πρέπει να ανακυκλώνονται με τρόπο φιλικό προς το περιβάλλον.



Δεν επιτρέπεται να πετάτε ηλεκτρικές συσκευές και μπαταρίες στα οικιακά απορρίμματα!

Μόνο για χώρες ΕΕ:

Σύμφωνα με την ισχύουσα Ευρωπαϊκή Οδηγία σχετικά με άχρηστες ηλεκτρικές και ηλεκτρονικές συσκευές και την εφαρμογή της σε εθνικό δίκαιο πρέπει οι άχρηστες πλέον ηλεκτρικές συσκευές και οι μπαταρίες να αποσύρονται ξεχωριστά και να οδηγούνται σε ανακύκλωση φιλική προς το περιβάλλον.

9. Εγγύηση κατασκευαστή

Αυτό το προϊόν STEINEL κατασκευάστηκε με μέγιστη προσοχή, ελέγχθηκε σχετικά με τη λειτουργία του και την τεχνική του ασφάλεια σύμφωνα με τους ισχύοντες κανονισμούς και κατόπιν υποβλήθηκε σε δειγματοληπτικό έλεγχο. Η εταιρία STEINEL αναλαμβάνει την εγγύηση για απρόσκοπτη κατάσταση και λειτουργία. Ο χρόνος εγγύησης ανέρχεται σε 36 μήνες και αρχίζει με την ημέρα πώλησης στον καταναλωτή. Επιδιορθώνουμε ελαττώματα, τα οποία οφείλονται σε σφάλματα υλικού ή εργοστασίου, η εγγυητική απαίτηση εκπληρώνεται με επισκευή ή αντικατάσταση ελαττωματικών εξαρτημάτων σύμφωνα με δική μας επιλογή. Η εγγυητική απαίτηση εκπίπτει για βλάβες σε φθειρόμενα εξαρτήματα όπως επίσης για βλάβες και ελαττώματα που οφείλονται σε ακατάλληλο χειρισμό ή ακατάλληλη συντήρηση. Περαιτέρω επακόλουθες βλάβες σε ξένα αντικείμενα αποκλείονται.

Η εγγύηση παρέχεται μόνο εφόσον η συσκευή αποσταλεί σε μη αποσυναρμολογημένη μορφή με σύντομη περιγραφή βλάβης, απόδειξη ταμείου ή τιμολόγιο (ημερομηνία αγοράς και σφραγίδα εμπόρου), καλά συσκευασμένη στην αρμόδια υπηρεσία σέρβις.

Σέρβις επισκευής: Για επισκευές μετά την πάροδο του χρόνου εγγύησης ή επισκευές ελαττωμάτων χωρίς εγγυητική απαίτηση απευθυνθείτε στο πλησιέστερο σέρβις για να πληροφορηθείτε τη δυνατότητα επισκευής.

3 E T H
ΚΑΤΑΣΚΕΥΑΣΤΗ
ΕΓΓΥΗΣΗ

10. Τεχνικά δεδομένα

- Διαστάσεις (Υ × Π × Β): 95 × 95 × 38 mm
- Σύνδεση δικτύου: 220-240 V, 50/60 Hz
- Κατανάλωση ισχύος: *NightmatIQ* < 0,7 W
NightmatIQ plus < 0,5 W
- Ρύθμιση ευαισθησίας: *NightmatIQ*: 1-75 Lux
NightmatIQ plus: 1-1.000 Lux
- Σύστημα αισθητήρα: Φωτοτρανζίστορ
- Όρια θερμοκρασίας: -20 έως +40 °C
- Συχνότητα Bluetooth (μόνο *NightmatIQ plus*): 2,4-2,48 GHz
- Ισχύς εκπομπής Bluetooth (μόνο *NightmatIQ plus*): 4 dBm/2,5 mW
- Είδος προστασίας: IP 54

Ικανότητα μεταγωγής

- Λαμπτήρας πυράκτωσης/αλογόνου: 1.000 W
- Λαμπτήρες αλογόνου χαμηλής τάσης: 1.000 VA
- Λαμπτήρες φθορισμού χωρίς αντιστάθμιση: 500 VA
- Λαμπτήρες φθορισμού σειριακή αντιστάθμιση: 500 VA
- Λαμπτήρες φθορισμού παράλληλη αντιστάθμιση: 500 VA
- Λαμπτήρες φθορισμού στραγγαλιστικό πηνίο EVG: 250 W
- Λυχνίες LED <2W: 100 W
- Λυχνίες LED >2W <8W: 125 W
- Λυχνίες LED >8W: 250 W
- Χωρητικό φορτίο: 88 μF

11. Αποκατάσταση βλάβης

Συσκευή χωρίς τάση

- Ασφάλεια μη ενεργοποιημένη ή ελαττωματική.
 - Ενεργοποιήστε την ασφάλεια.
 - Αντικαταστήστε την ελαττωματική ασφάλεια.
- Διακόπηκε το κύκλωμα.
 - Ελέγξτε το κύκλωμα με δοκιμαστικό τάσης.
- Βραχυκύκλωμα στο δίκτυο τροφοδοσίας.
 - Ελέγξτε τις συνδέσεις.
- Ενδεχομένως διακόπτης δικτύου εκτός.
 - Ενεργοποιήστε τον διακόπτη δικτύου.

Η συσκευή δεν ενεργοποιείται.

- Λανθασμένη επιλογή ρύθμισης ορίου ευαισθησίας.
 - Ρυθμίστε εκ νέου τη ρύθμιση ευαισθησίας.
- Διακόπτης δικτύου ΕΚΤΟΣ.
 - Ρυθμίστε τον διακόπτη δικτύου.
- Ασφάλεια μη ενεργοποιημένη ή ελαττωματική.
 - Ενεργοποιήστε την ασφάλεια.
 - Αντικαταστήστε την ελαττωματική ασφάλεια.

İçerik

1.	Bu doküman hakkında	3
2.	Genel güvenlik uyarıları	3
3.	Cihaz açıklaması	4
4.	Elektrik bağlantısı	9
5.	Montaj	10
6.	Fonksiyon	19
7.	Temizlik ve koruyucu bakım	24
8.	Tasfiye	24
9.	Üretici garantisi	25
10.	Teknik özellikler	26
11.	Sorun giderme	27

1. Bu doküman hakkında

- Telif hakları korunmaktadır. Kısmen de olsa basılması, ancak onayımız alınarak mümkündür.
- Teknik gelişmelere hizmet eden değişiklikler yapma hakkı saklıdır.



Tehlikelere karşı uyarı!



Elektrikten kaynaklanan tehlikelere karşı uyarı!



Sudan kaynaklanan tehlikelere karşı uyarı!

2. Genel güvenlik uyarıları



Kullanım kılavuzunun dikkate alınmaması nedeniyle tehlike!

Bu kılavuzda, cihazın emniyetli kullanımı için önemli bilgiler yer almaktadır. Olası tehlikeler özellikle vurgulanmıştır. Dikkate alınmaması halinde, ölüm veya ağır yaralanmalar meydana gelebilir.

- Kılavuzu dikkatli okuyun.
- Güvenlik uyarılarına riayet edin.
- Erişilebilir şekilde saklayın.
- Elektrik akımıyla yapılan çalışmalar, tehlikeli durumlara yol açabilir. Elektrik ileten parçalara dokunmak, elektrik çarpmasına, yanıklara veya ölüme yol açabilir.
- Şebeke gerilimindeki çalışma, yalnızca uzman teknik personel tarafından yapılabilir.
- Ülkeye özgü kurulum yönergeleri ve bağlantı koşulları dikkate alınmalıdır (örn. DE: VDE 0100, AT: ÖVE-Ö-NORM E8001-1, CH: SEV 1000).
- Sadece orijinal yedek parçalar kullanın.
- Onarımlar yalnızca uzman şirketler tarafından yapılabilir.

3. Cihaz açıklaması

Amacına uygun kullanım NighmatIQ

- Alacakaranlık anahtarı, iç ve dış mekanda duvara montaj için uygundur.
- Alacakaranlık ayarı işlevi, potansiyometreyle ayarlanabilir.
- Münferit sensör olarak kullanılabilir.

Amacına uygun kullanım NighmatIQ Plus

- Alacakaranlık anahtarı, iç ve dış mekanda duvara montaj için uygundur.
- İşlevler, Steinel Connect App üzerinden ayarlanabilir.
- Münferit sensör olarak veya Bluetooth ile ağda kullanılabilir.

Fonksiyon prensibi

- Alacakaranlık anahtarı, ışık sensörünün yardımıyla ortam parlaklığını algılar ve bunu, ayarlanmış olan parlaklık eşiği değeri ile karşılaştırır.
- Ortam parlaklığı parlaklık eşiği değerinin altındaysa, bağlanmış olan tüketici çalıştırılır.
- Ortam parlaklığı parlaklık eşiği değerinin üzerindeyse, bağlanmış olan tüketici kapatılır.

Teslimat kapsamı NightmatIQ / NightmatIQ Plus

3.1

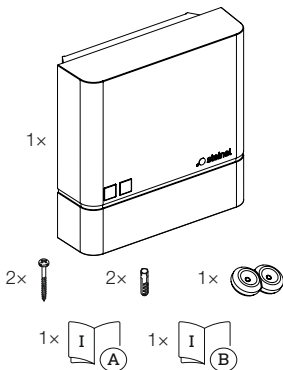

- 1 NightmatIQ / NightmatIQ Plus
- 2 vida
- 2 dübel
- 1 Tapa
- 1 Güvenlik Bilgi Formu
- 1 Hızlı Başlatma Kılavuzu

Ürün boyutları NightmatIQ / NightmatIQ Plus

3.2

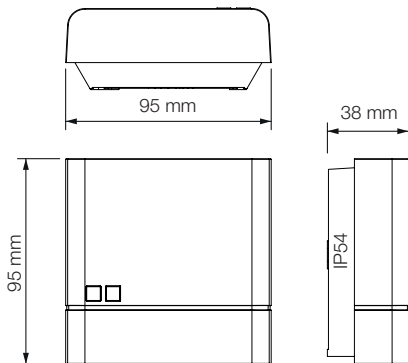

Cihazın genel görünümü NightmatIQ

3.3

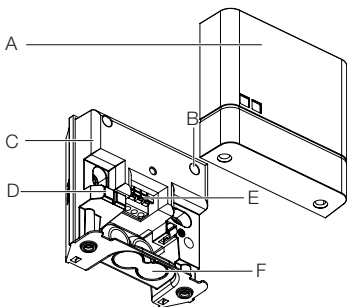

- A Kapak
- B Potansiyometre Alacakaranlık ayarı
- C Gövde Alacakaranlık anahtarı
- D Parlaklık sensörü
- E Bağlantı terminali
- F Sıva üstü kablolama için isteğe bağlı boşluk

3.4



- G Detay: Potansiyometre Alacakaranlık ayarı

Cihazın genel görünümü NightmatIQ Plus

3.5

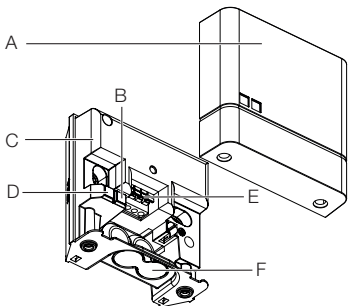

- A Kapak
- B Durum LED'i
- C Gövde Alacakaranlık anahtarı
- D Parlaklık sensörü
- E Bağlantı terminali
- F Sıva üstü kablolama için isteğe bağlı boşluk

4. Elektrik bağlantısı

Devre şeması

4.1

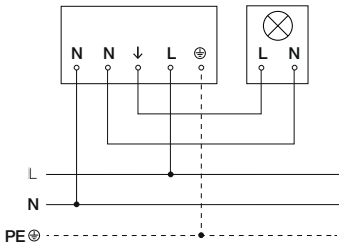

Elektrik kablosu, 3 iletkenli bir kablodur:

- L** = Faz (genellikle siyah, kahverengi veya gri)
- N** = Nötr hattı (genellikle mavi)
- PE** = Topraklama hattı (yeşil/sarı)

Şebeke anahtarının her zaman açık olduğundan emin olunması halinde, cihaz elektriksiz olarak bir şebeke anahtarından sonra da bağlanabilir.

Sızdırmazlık tapaları, dış çapı 5-10 mm olan bir elektrik kablosu için öngörülmüştür.

5. Montaj



Elektrik akımı nedeniyle tehlike!

Elektrik ileten parçalara dokunmak, elektrik çarpmasına, yanıklara veya ölüme yol açabilir.

- Elektriği kapatın ve elektrik beslemesini kesin.
- Elektriğin kesik olduğunu, kontrol kalemi ile kontrol edin.
- Elektrik beslemesinin kesik kalacağından emin olun.

Maddi hasar tehlikesi!

Bağlantı tesisatlarının karıştırılması, kısa devreye yol açabilir.

- Bağlantı tesisatlarını tanımlayın.
- Bağlantı tesisatlarını doğru bağlayın.

Montaj hazırlığı

- Bütün yapı parçalarında hasar kontrolü yapın. Hasarlar olduğunda, cihazı işleme almayın.
- Uygun montaj yerini seçin.
 - Titreşimsiz.
 - Patlama tehlikesi olmayan bölgelerde.
 - Kolay tutuşmayan yüzeylerin üzerinde.
 - Cihaz, bağlanmış olan tüketicinin ışığından etkilenmemelidir.

Montaj adımları

5.1

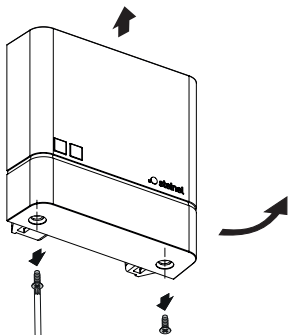

- Elektrik beslemesini kapatın.
- Elektrik beslemesinin kapatıldığını kontrol edin.
- Kapağın vidalarını çözün ve çıkartın.

5.2

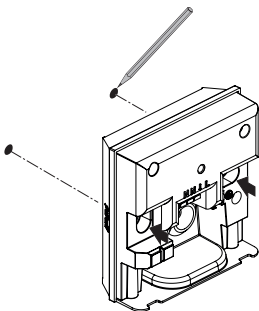

- Delik yerlerini işaretleyin.

5.3

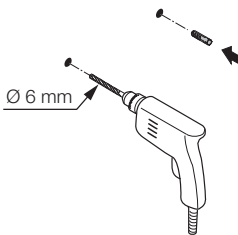

- Delikleri delin (ø 6 mm) ve dübelleri yerleştirin.

Sıva altı seçeneđi

5.4

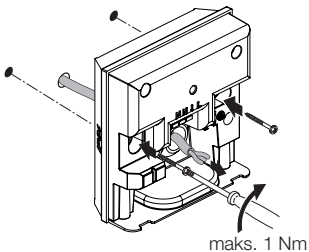

- Kabloyu, cihazın içinden geçirin.
- Cihazı, maks. 1 Nm'lik bir torkla vidalayın.

Sıva üstü seçeneği

5.5

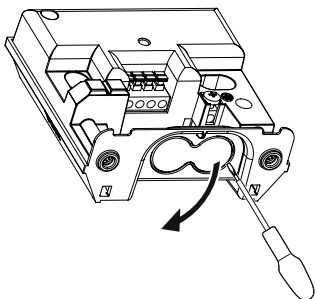

- Sıva üstü kablolama için isteğe bağlı boşluğu, bir tornavidayla dikkatlice kırıp ayırın.

5.6

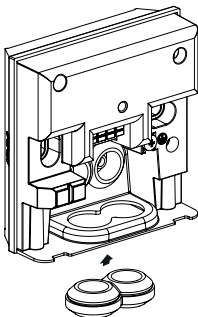

- Tapayı yerleştirin.

5.7

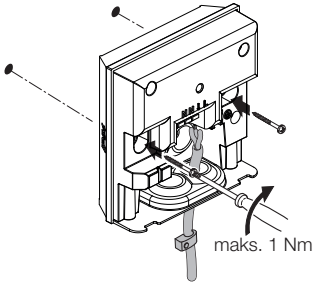

- Kabloyu, cihazın içinden geçirin.
- Cihazı, maks. 1 Nm'lik bir torkla vidalayın.

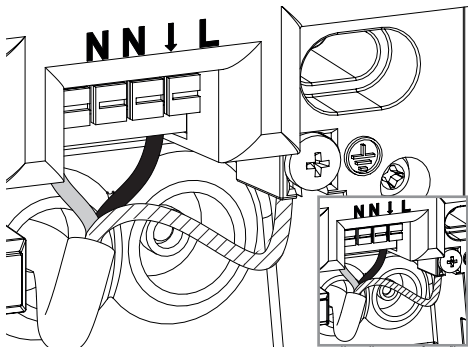

- Elektrik beslemesini devre şemasına göre bağlayın.
→ „4. Elektrik bağlantısı“

5.9

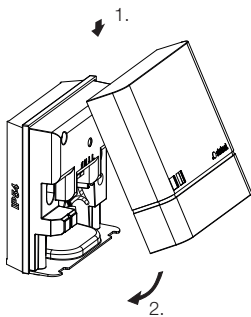

- Kapađı oturtun.

5.10

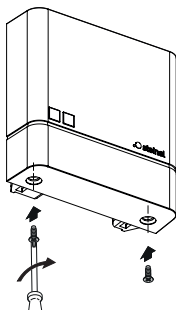

- Kapađı vidalayın.



- Elektrik beslemesini açın.
 - Fonksiyonları ayarlayın.
- „6. Fonksiyon“

6. Fonksiyon

NightmatIQ

NightmatIQ ile alacakaranlık ayarı, alacakaranlık ayar potansiyometresi üzerinden manuel olarak yapılır.



Elektrik akımı nedeniyle tehlike!

Elektrik ileten parçalara dokunmak, elektrik çarpmasına, yanıklara veya ölüme yol açabilir.

- Elektriği kapatın ve elektrik beslemesini kesin.
- Elektriğin kesik olduğunu, kontrol kalemi ile kontrol edin.
- Elektrik beslemesinin kesik kalacağından emin olun.

- **Fabrika ayarları**

- Alacakaranlık ayarı: 75 Lux

Alacakaranlık ayarı (G)

Devreye girme parlaklığı (alacakaranlık), yak. 1-75 Lux arasında kademesiz olarak ayarlanabilir.

- ☀ = Alacakaranlık işletimi (yak. 75 Lux)
- ☾ = Alacakaranlık işletimi/Gece işletimi (yak. 1 Lux)

Manuel alacakaranlık ayarı NightmatIQ

6.1

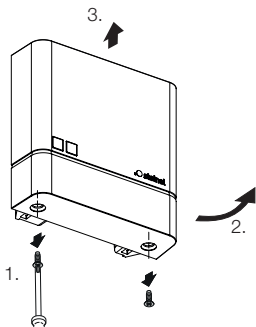

- Elektrik beslemesini kapatın.
- Elektrik beslemesinin kapatıldığını kontrol edin.
- Kapağın vidalarını çıkartın.

6.2

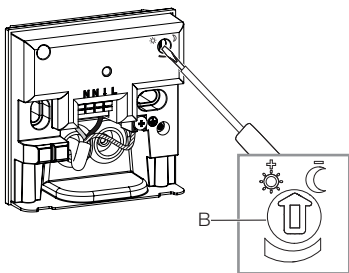

- Alacakaranlık ayarının istenilen tepkime eşikliğini, tornavida ile kademesiz olarak ayarlayın.

6.3

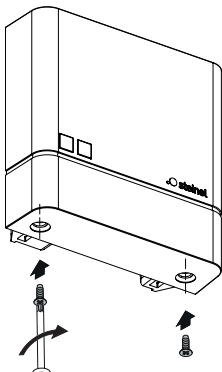

- Kapağı vidalayın.

6.4



- Elektrik beslemesini açın.

NightmatIQ Plus

NightmatIQ Plus için fonksiyonların ayarı, Steinel Connect App üzerinden yapılır.

Steinel Connect App

Cihazın akıllı telefon veya tablet ile yapılandırılması için STEINEL Connect App, AppStore'unuzdan indirilmelidir. Bluetooth uyumlu bir akıllı telefon veya Tablet gereklidir.



Android



iOS



Steinel Connect App kullanılarak ayarlanabilen fonksiyonlar şunlardır:

- Alacakaranlık ayarı.

Not:

Hatalı fonksiyonları önlemek için, WLAN yönlendiricisine ve erişim noktalarına 3 m'lik bir asgari mesafe bırakılmalıdır.

LED fonksiyonu

Başlatma: LED aralıksız beyaz yanar.

Normal işletim: LED kapalı.

Tanımlama: LED yavaşça yanıp söner.

Yazılım güncellemesi: LED hızlı yanıp söner.

Hata: LED hızlı yanıp söner.

Fabrika ayarları

- Alacakaranlık ayarı: 1.000 Lux

Alacakaranlık ayarı

Devreye girme parlaklığı (alacakaranlık), yak. 1-1.000 Lux arasında kademesiz olarak ayarlanabilir.

- ☀ = Alacakaranlık işletimi (yak. 1.000 Lux)
- ☾ = Alacakaranlık işletimi/Gece işletimi (yak. 1 Lux)

Bluetooth ağ sistemi (Bluetooth Mesh)

Sensörlü anahtar, Bluetooth Mesh standardına uygundur. Bluetooth Mesh standardına uygun tüm ürünlerle ağa bağlanabilir.

Sensörlü anahtar, Steinel Connect App kullanılarak yapılandırılır. Sensörlü anahtar ile Steinel Connect App arasında kurulan ilk bağlantıda, ilgili ağ anahtarları akıllı telefona veya tablete kaydedilir. Anahtar vasıtasıyla, sensöre yetkisiz erişim engellenir.

Ağ anahtarı, başka bir akıllı telefon veya tablet üzerinden erişim için paylaşılmalıdır.

Çalıştırma zamanları

Alacakaranlık değerini ayarlamanın yanı sıra App üzerinden, bağlanmış olan tüketicilerin AÇIK ya da KAPALI oldukları anahtarlama zamanları da ayarlanabilir.

NightmatIQ plus, bir akıllı telefon/tablet ile Bluetooth bağlantısı aracılığıyla güncel saati alır ve bunu, gelecekteki çalıştırma işlemleri için kullanır.

NightmatIQ plus'ın güç beslemesi kesilirse, kaydedilmiş olan zamanı kaybeder. NightmatIQ plus, güneşin önceki günlerdeki seyrine göre yaklaşık bir saat belirler. Tam saati geri yüklemek için, uygulamayla yeniden bir bağlantı kurulması gerekir.

7. Temizlik ve koruyucu bakım

Cihaz bakım gerektirmez.



Elektrik akımı nedeniyle tehlike!

Elektrik ileten parçalara suyun teması, elektrik çarpmasına, yanıklara veya ölüme yol açabilir.

- Cihazı yalnızca kuru haldeyken temizleyin.

Maddi hasar tehlikesi!

Yanlış temizlik maddeleri nedeniyle, cihaz zarar görebilir.

- Cihazı, deterjan kullanmadan hafif nemli bir bezle temizleyin.

8. Tasfiye

Elektrikli cihazlar, piller, aksesuar ve ambalajlar, çevre dostu bir dönüşüme gönderilmelidir.



Elektrikli cihazları ve pilleri evsel atıkların içine atmayın!

Sadece AB ülkeleri için:

Atık Elektrikli ve Elektronik Cihazlar için geçerli olan Avrupa yönergesine ve bunun dönüştüğü ulusal yasaya göre, artık kullanılamayacak haldeki elektrikli cihazların ve pillerin ayrı toplanması ve bir çevre dostu geri dönüşüme gönderilmesi zorunludur.

9. Üretici garantisi

Bu STEINEL ürünü, büyük bir itinayla üretilmiş, fonksiyon ve güvenlik kontrolleri geçerli talimatlar uyarınca yapılmış ve ardından bir numune kontrolüne tabi tutulmuştur. STEINEL, kusursuz nitelik ve fonksiyon garantisi vermektedir. Garanti süresi 36 ay olup, kullanıcıya satış tarihi itibarıyla başlar. Malzeme ve fabrikasyon hatalardan kaynaklanan kusurlar tarafımızca giderilmektedir; garanti hizmeti, tercihimize bağlı olarak kusurlu parçaların onarımı veya değişimi şeklinde gerçekleşir. Garanti hizmeti, aşınma parçalarındaki hasarları, usulüne aykırı uygulama veya bakım sonucunda meydana gelen hasar ve kusurları kapsamaz. Yabancı cisimlere yansıyan dolaylı zararlar, garanti kapsamı dışındadır.

Garanti yükümlülüğü ancak, cihazın açılmamış halde kısa hata açıklaması, kasa fişi veya faturasıyla (satış tarihi ve satıcı kaşesi) birlikte, tam ambalajlanmış şekilde ilgili servis istasyonuna gönderilmesi durumunda geçerlidir.

Onarım servisi:

Garanti süresinin dolması veya garanti kapsamına girmeyen kusurlar halinde, onarım olanağı konusunda lütfen en yakın servis istasyonuna danışınız.

3 Y I L
ÜRETİCİ
GARANTİSİ

10. Teknik özellikler

- Boyutlar (Y x G x D): 95 x 95 x 38 mm
- Şebeke bağlantısı: 220-240 V, 50/60 Hz
- Çekilen güç: *NightmatIQ* < 0,7 W
NightmatIQ plus < 0,5 W
- Alacakaranlık ayarı: *NightmatIQ*: 1-75 Lux
NightmatIQ plus: 1-1.000 Lux
- Algılama sistemi: Fototransistor
- Sıcaklık aralığı: -20 ila +40 °C
- Bluetooth frekansı (sadece *NightmatIQ plus*): 2,4-2,48 GHz
- Bluetooth verici gücü (sadece *NightmatIQ plus*): 4 dBm/2,5 mW
- Koruma türü: IP 54

Çalıştırma gücü

- Akkor/halojen ampul yükü: 1.000 W
- Alçak voltaj halojen ampuller: 1.000 VA
- Floresan ampuller, dengesiz: 500 VA
- Floresan ampuller, seri dengeli: 500 VA
- Floresan ampuller, paralel dengeli: 500 VA
- Floresan ampuller EVG: 250 W
- LED lambalar <2W: 100 W
- LED lambalar >2W <8W: 125 W
- LED lambalar >8W: 250 W
- Kapasitif yükleme: 88 µF

11. Sorun giderme

Cihazda elektrik yok.

- Sigorta alıřtırılmamıř veya arızalı.
 - Sigortayı alıřtırın.
 - Arızalı sigortayı deęiřtirin.
- Kablo kopuk.
 - Kabloyu avometre ile gzden geirin.
- Elektrik kablosunda kısa devre.
 - Baęlantıları gzden geirin.
- Muhtemelen, mevcut elektrik anahtarı kapalı.
 - Elektrik anahtarını alıřtırın.

Cihaz alıřmıyor.

- Alacakaranlık ayarı yanlıř seilmiř.
 - Alacakaranlık ayarını yeniden ayarlayın.
- Elektrik anahtarı KAPALI.
 - Elektrik anahtarını ayarlayın.
- Sigorta alıřtırılmamıř veya arızalı.
 - Sigortayı alıřtırın.
 - Arızalı sigortayı deęiřtirin.

STEINEL Vertrieb GmbH
Dieselstraße 80-84
33442 Herzebrock-Clarholz
Tel: +49/5245/448-188
www.steinel.de



Contact

www.steinel.de/contact

